

PERFECT ORDER

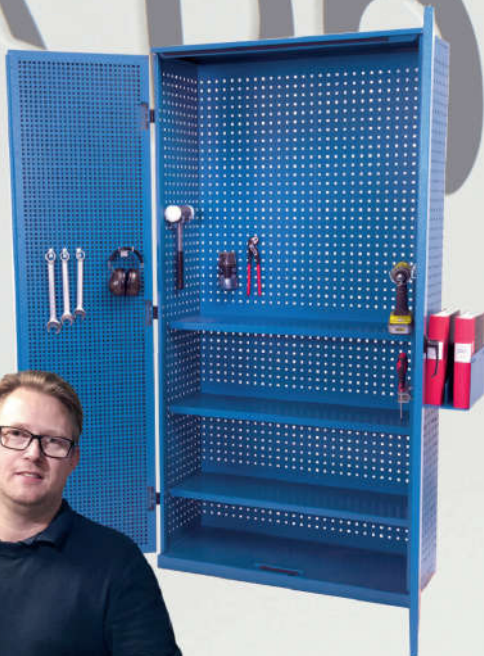

One of Europe's
biggest range
of hooks

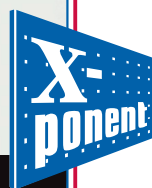

X-ponent
inredning

Welcome!

Here at X-ponent Inredning, we always try to provide you with the very best service and the best products on the market for workshop, warehouse and industrial use.

Choose from our quality products and smart solutions.

With our range of hooks – one of Europe's biggest – you will soon have your workplace in perfect order.



Made in Sweden
We manufacture to the highest quality.

PAGE 4



WORKBENCHES

PAGE 22



TOOL CASSETTES

PAGE 26



WORKSHOP CABINETS

PAGE 10

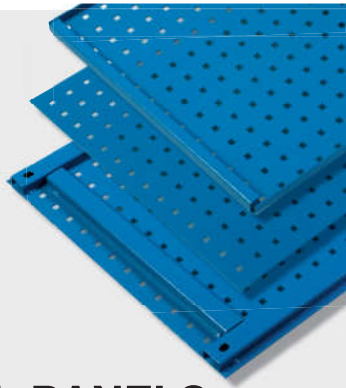

TOOL PANELS

PAGE 15



**ACCESSORIES
SPARE PARTS**

PAGE 18



**SCREENS AND
ACOUSTIC WALLS**

PAGE 32



**TOOL CARTS –
WORKSHOP TROLLEYS**

PAGE 38



HOOKS

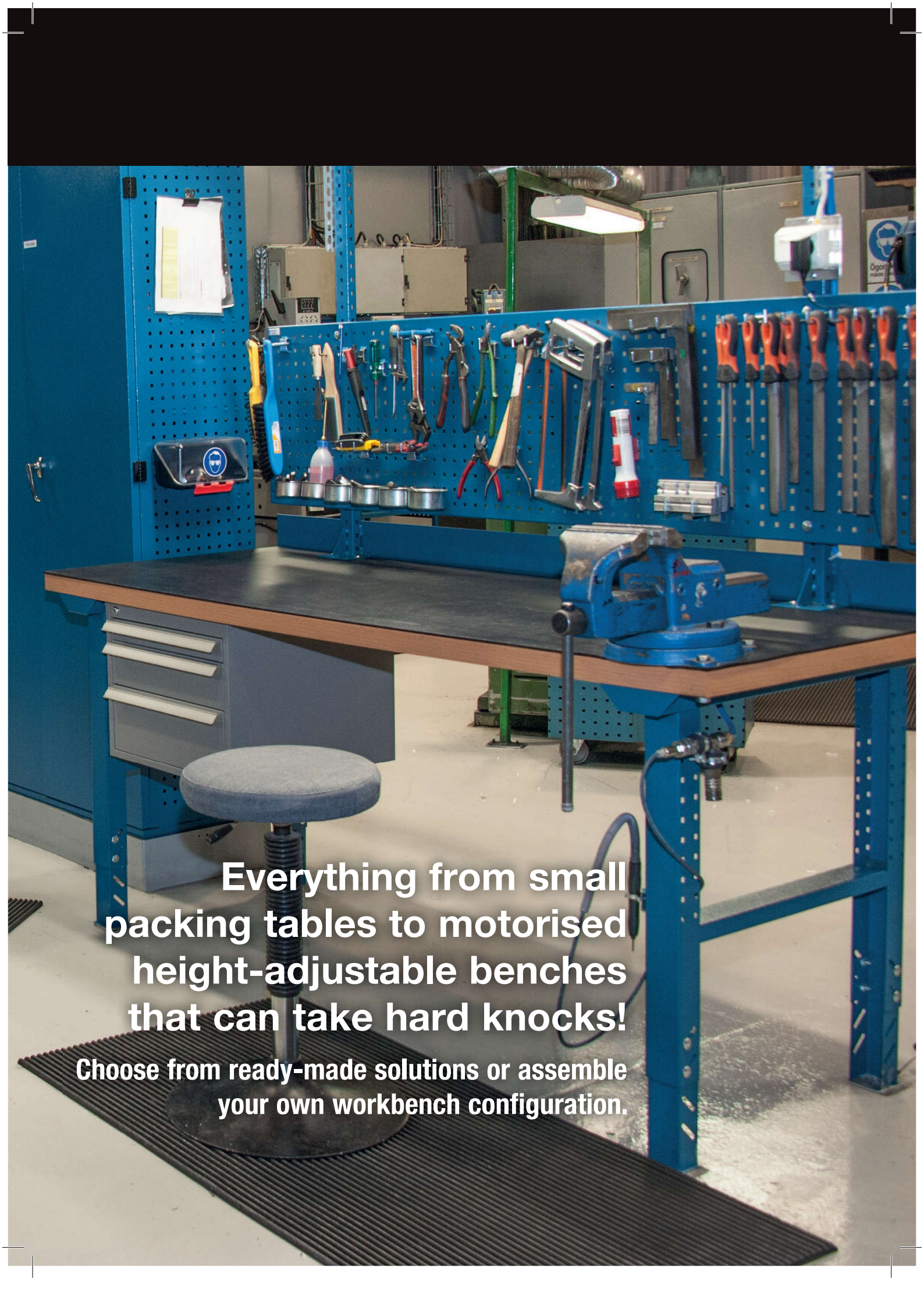

**Everything from small
packing tables to motorised
height-adjustable benches
that can take hard knocks!
Choose from ready-made solutions or assemble
your own workbench configuration.**

WORKBENCHES

- Assembly
- Dismantling
- Picking
- Packing
- Workshop
- Automotive

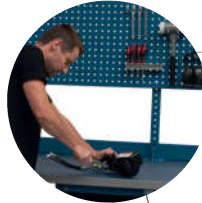

A tool board directly next to the bench saves time, as your tools are always close to hand!

A vinyl mat provides a protective, easy-to-clean work surface

A lower shelf easily makes a temporary storage area for e.g. boxes when the bench is used as a packing table.

Drawers create space for everything from pens to extra blades for your cutter. Add drawer dividers for even greater tidiness.



Assembly, dismantling, picking and packing.

Ready-made
solutions help
you get everything
neat and tidy.

WORKBENCH BASIC



Good start! Workbench top with hard-wearing vinyl mat, adjustable bench pillars.

1000 mm **Item no.** 12.20.01-1
1500 mm **Item no.** 12.20.01-2
2000 mm **Item no.** 12.20.01-3

WORKBENCH 2



Workbench top with hard-wearing vinyl mat, raised edge, adjustable bench pillars, 1 bench drawer, H: 150 mm.

1000 mm **Item no.** 12.20.02-1
1500 mm **Item no.** 12.20.02-2
2000 mm **Item no.** 12.20.02-3

WORKBENCH 3



Workbench top with hard-wearing vinyl mat, raised edge, adjustable bench pillars, 2 bench drawers, H: 150 mm.

1500 mm **Item no.** 12.20.03-2
2000 mm **Item no.** 12.20.03-3

WORKBENCH 4



Workbench top with hard-wearing vinyl mat, raised edge, adjustable bench pillars, 1 3-drawer pedestal cabinet: H: 1x50 mm, 1x100 mm, 1x150 mm

1000 mm **Item no.** 12.20.04-1
1500 mm **Item no.** 12.20.04-2
2000 mm **Item no.** 12.20.04-3

WORKBENCH 5



Workbench top with hard-wearing vinyl mat, raised edge, adjustable bench pillars, 2 3-drawer pedestal cabinets: H: 2x50 mm, 2x100 mm, 2x150 mm

1500 mm **Item no.** 12.20.05-2
2000 mm **Item no.** 12.20.05-3

WORKBENCH 6



Workbench top with hard-wearing vinyl mat, raised edge, adjustable bench pillars plus adjusting feet on 5-drawer floor cabinet:

H: 1x50 mm, 1x100 mm, 3x150 mm
1000 mm **Item no.** 12.20.06-1
1500 mm **Item no.** 12.20.06-2
2000 mm **Item no.** 12.20.06-3

WORKBENCH 7 COMPLETE



Complete bench with hard-wearing vinyl mat, adjustable bench pillars, 3-drawer pedestal cabinet, lower shelf, raised edge, tool board.

1000 mm (without lower shelf) **Item no.** 12.08.30
1500 mm **Item no.** 12.08.31
Set of hooks for bench 1500 **Item no.** 15.80.02
2000 mm **Item no.** 12.08.41
Set of hooks for bench 2000 **Item no.** 15.80.03

MOTORISED HEIGHT-ADJUSTABLE BENCH 8 COMPLETE



Complete motorised height-adjustable workbench with hard-wearing vinyl mat, raised edge, tool board. Lifting force 200 kg distributed load

1000 mm **Item no.** 12.08.10
1500 mm **Item no.** 12.08.11
Set of hooks for bench 1500 **Item no.** 15.80.02
2000 mm **Item no.** 12.08.12
Set of hooks for bench 2000 **Item no.** 15.80.03

CHIPBOARD



Chipboard ideal as a base for a steel plate cover accessory, Pre-fitted M8 Tee nuts for easy assembly of bench pillars, electric lifting columns and pedestal cabinets.

1000 x 750 x 40 mm (L x W x H) **Item no.** 12.07.51
 1500 x 750 x 40 mm **Item no.** 12.07.71
 2000 x 750 x 40 mm **Item no.** 12.08.71

WORKBENCH TOP IN EDGE-GLUED BEECH



Workbench top ideal as a base for a steel plate cover accessory.

* Manufactured to order.

1000 x 750 x 38 mm (L x W x H) **Item no.** 12.07.53*
 1500 x 750 x 38 mm **Item no.** 12.08.51*
 2000 x 750 x 38 mm **Item no.** 12.08.61*

WORKBENCH TOP PVC



Workbench top with hard-wearing vinyl mat and pre-fitted M8 Tee nuts for easy assembly of bench pillars, electric lifting columns and pedestal cabinets.

1000 x 750 x 42 mm (L x W x H) **Item no.** 12.07.52
 1500 x 750 x 42 mm **Item no.** 12.06.73
 2000 x 750 x 42 mm **Item no.** 12.06.72

BENCH PILLARS



Stable and adjustable bench legs that provide a fully adjustable working height from 790 to 940 mm.

Bench pillar 750 (single)

Item no. 12.06.51

ELECTRIC LIFTING COLUMNS



Complete kit for assembly to workbench. Motorised height-adjustable.

* On request

Electric lifting columns (pair):
 Lifting force 300 kg
 Lifting force 500 kg

Item no. 12.08.93
Item no. 12.08.94*

BENCH PILLARS FOR TOOL BOARD XB



Screws included for assembly to workbench.

Bench pillar (pair) H 1100 mm
 Bench pillar (pair) H 1465 mm

Item no. 12.03.31
Item no. 12.03.41

TOOL BOARD FOR BENCH PILLARS

Powder-coated tool board. Optimise your workplace and make it neat and tidy.



XB-1 903 x 470 mm (L x W) **Item no.** 10.10.01
 XB-2 928 x 903 mm **Item no.** 10.11.01
 XB-2/1 1480 x 470 mm **Item no.** 10.11.11
 XB-2/2 1480 x 903 mm **Item no.** 10.12.01
 XB-3 1930 x 903 mm **Item no.** 10.13.01
 XB-3/2 1930 x 470 mm **Item no.** 10.14.01

STEEL PLATE COVER/METAL TOP



Powder-coated steel plate cover provides your workbench with additional protection.

Steel plate cover-1000 1000 x 750 mm (L x W) **Item no.** 12.06.09
 Steel plate cover-1500 1500 x 750 mm **Item no.** 12.06.21
 Steel plate cover-2000 2000 x 750 mm **Item no.** 12.06.31

REAR EDGE STRIP/RAISED EDGE



With a simple rear edge strip, you can prevent things falling off the bench.

Back stop-1000 1000 mm **Item no.** 12.04.61
 Back stop-1500 1500 mm **Item no.** 12.06.61
 Back stop-2000 2000 mm **Item no.** 12.07.61

LOWER SHELF



The lower shelf is fitted between the bench pillars and provides additional storage space.

Lower shelf-1000 770 x 515 mm (L x W) **Item no.** 12.06.22
 Lower shelf-1500 1270 x 515 mm **Item no.** 12.05.11
 Lower shelf-2000 1770 x 515 mm **Item no.** 12.06.11

BENCH DRAWER



Lockable with cylinder lock. 100% pull-out drawer. Drawer height 150 mm.

150 x 440 x 505 mm (H x W x D) **Item no.** 12.09.01

BENCH PEDESTAL CABINET-3

Three pull-out drawers on ball bearings. Lockable with cylinder lock. 100% pull-out drawers. Drawer heights: 1x50 mm, 1x100 mm, 1x150 mm.



385 x 488 x 505 mm (H x W x D) **Item no.** 12.10.01

BENCH PEDESTAL CABINET-5

Five pull-out drawers on ball bearings. Lockable with cylinder lock. 100% pull-out drawers. Drawer heights: 1x50 mm, 1x100 mm, 3x150 mm



769 x 488 x 505 mm (H x W x D) **Item no.** 12.11.02

DRAWER DIVIDER



Kit with 6 flexible frames that are self-locking and can be positioned wherever you want in the drawer. Fit all drawers.

Height 47 mm

Item no. 12.10.53

WHEELFRAME FOR BENCH PEDESTAL CABINET

Incl. 4 lockable swivelling wheels. Ø 100 mm. Increases the height of the pedestal cabinet by 120 mm.



488 x 488 mm (L x W)

Item no. 12.12.03

WORKBENCH TOP IN PVC

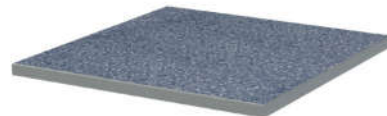

Workbench top/top for bench pedestal cabinet. Increases the height of the pedestal cabinet by 21 mm.

500 x 483 x 21 mm (L x W x H) **Item no.** 12.11.70

BASE FOR BENCH PEDESTAL CABINET



Increases the height of the pedestal cabinet by 120 mm

485 x 505 mm (L x W)

Item no. 12.12.04

Build your own pedestal cabinet

Select one or two frames. Configure the drawer sizes you require. Each frame must however total 300. E.g. 6x drawer 50 or 2x drawer 150. Regardless of the number of frames and the drawer sizes you choose, all of them are lockable via a central lock.



Frame
Item no. 12.10.05



Drawer 50
Item no. 12.10.02



Drawer 100
Item no. 12.10.03



Drawer 150
Item no. 12.10.04

Special solutions

Tip for smart
X-ponent solutions!



Optimised bench for manufacture of hydraulic hoses



Bench with X-ponent's
Roll-X roller front cabinet



Robust bench for welding jobs



Store display



Pedestal cabinet trolley



**Use the whole wall
with X-ponent's tool panels**

TOOL PANELS

2 mm steel

Allows flexibility in use.
Handles everything from
light to heavy loads.

Resistant textured paint finish

Longer life.

Short lead time

Always in stock.

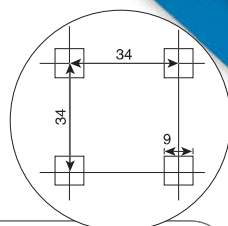

Original

X-ponent original perforation.
Standard since 1937.

CC 34 mm
9 mm holes



Made in Sweden

We manufacture to the highest quality.

A REALLY GREAT TOOL PANEL

TOOL PANEL XB – BASE PANEL

Tool panels are the basis for making your workplace neat and tidy. The bent-over edges ensure a stable tool board that can be fitted to bench pillars or directly to the wall. Fully compatible with X-ponent's extensive range of hooks.

XB-1	903 x 470 mm (L x W)	Item no. 10.10.01
XB-2	925 x 903 mm	Item no. 10.11.01
XB-2/1	1480 x 470 mm	Item no. 10.11.11
XB-2/2	1480 x 903 mm	Item no. 10.12.01
XB-3	1930 x 903 mm	Item no. 10.13.01
XB-3/2	1930 x 470 mm	Item no. 10.14.01
XB-4	2425 x 903 mm	Item no. 10.15.01* *) Manufactured to order

Contact us for other sizes!



GOOD START!

ROBUST SET OF HOOKS!

Set of hooks XB-1
20 hooks
Item no. 15.80.24

Set of hooks XB-2
41 hooks
Item no. 15.80.10

Set of hooks XB-3
94 hooks
Item no. 15.80.11

TOOL PANEL XA – FOR HEAVY LOADS

Recommended where very heavy loads can occur. Specially reinforced rear with welded U profile, resulting in a really sturdy tool panel that can take hard knocks!

XA-1	1000 x 500 mm (L x W)	Item no. 10.01.01
XA-2	1000 x 1000 mm	Item no. 10.02.01
XA-3	2000 x 1000 mm	Item no. 10.03.01
XA-6	1500 x 1000 mm	Item no. 10.05.01

Contact us for other sizes!

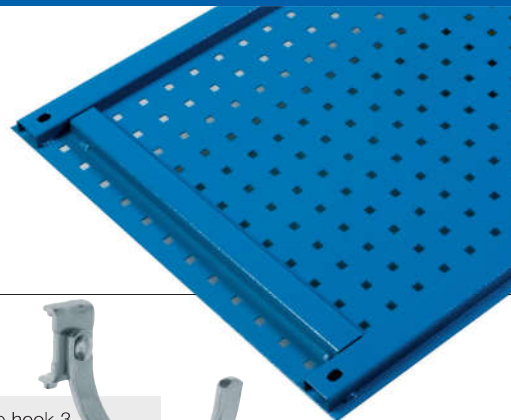

Hook 1B
L=150 mm, 10 mm steel wire with four-claw base
Item no. 20.12.03



Hook 2
L=140 mm, 8 mm steel wire with four-claw base
Item no. 20.16.10



Wide hook 3
150 mm Ø, 5 mm steel plate
Item no. 20.18.05

TOOL PANEL XC – CUSTOMISE IT YOURSELF

For vehicles or self-designed constructions. We have left the edges of the XC panel straight to make it easier for you to cut or bend them yourself to the desired dimensions. Also available in lightweight aluminium, making it ideal as a base panel when fitting out a vehicle.

XC-1	1000 x 500 mm (L x W)	Item no. 10.20.01
XC-2	1000 x 1000 mm	Item no. 10.21.01
XC-3	2000 x 1000 mm	Item no. 10.22.01
XC-3 ALU*	2000 x 1000 mm	Item no. 10.22.06 *) Aluminium grade equivalent to SS4125
XC-6	1500 x 1000 mm	Item no. 10.25.01

Contact us for other sizes!

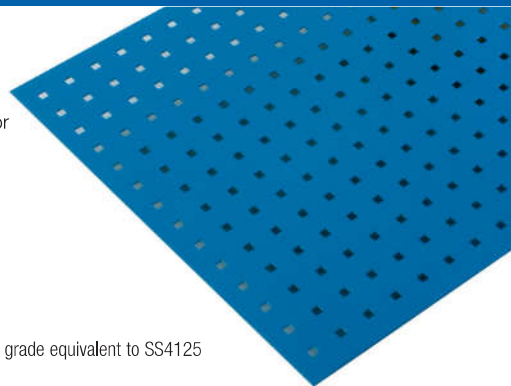

We manufacture the dimensions you need and powder-coat with the colour you want!

A REALLY GREAT TOOL PANEL

ALUMINIUM TOOL PANEL XB-5

Very lightweight panel.
Material grade:
equivalent to
ALU SS4125.
) Without handle.

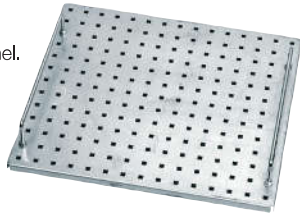

515 x 450 mm (L x W)
515 x 450 mm

Item no. 10.16.00
Item no. 10.16.06*

PORTABLE PANEL XB-6

The panel is a practical solution
that ensures a full overview of
and ready access to tools in the
workplace.
The panel comes
with supports, making
easy to position.

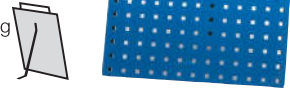

520 x 465 mm (L x W)

Item no. 10.17.01

WALL RAILS

Single rail X-1 and Double rail X-2.
In certain cases, the X-2 rail can replace
a wall panel
if mounted horizontally.

Hole dimensions:
9 x 9 mm, c/c distance 17 mm.

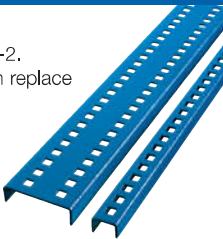

X-1 2000 x 26 x 19 mm (L x W x H)
X-2 2000 x 70 x 19 mm

Item no. 11.04.01
Item no. 11.05.01

SYSTEM PILLAR/STAND

Build your own fixed or mobile trolley.
Accommodates 2 XB panels (option)
back-to-back in dimensions of
your choosing.
Add 4 wheels 13.52.02 and
you have a mobile tool cart.

X-107 (pair)

H: 1260 mm
Rubber wheel, 100 mm,
Swivelling with brake.

Item no. 15.16.11
Item no. 13.52.02



PERF-X

VERTICAL STORAGE SYSTEM PERF-X – FOR EXTREMELY HEAVY ITEMS

Perf-X base pillar	Item no.	mm
Strong, withstands heavy loads. Perforated throughout on three sides.	11.06.01	2000
Perf-X foot	Item no.	mm
Bolt M8x65 included for fitting base pillar, plus 4 holes in the base plate for attaching to floor.	11.08.08	200 x 200
Perf-X Straight bracket	Item no.	mm
Strong bracket for fitting to Perf-X base pillar. Material dimensions 25 x 8 mm. Bolt M8x65 included.	11.11.04 11.11.05 11.11.06	400 500 600
Perf-X Hook 2	Item no.	mm
Extra strong wide hook for fitting to Perf-X base pillar. Material dimensions 25 x 10 mm. Bolt M8x65 included.	11.12.01 11.12.02	width 150 width 200
Perf-X Angle bracket	Item no.	mm
Strong bracket for fitting to Perf-X base pillar. Material dimensions 25 x 8 mm. Bolt M8x65 included.	11.11.10 11.11.11 11.11.12	400 x 175 500 x 200 600 x 200
Perf-X Floor and ceiling mounting bracket	Item no.	
For securing to floor or ceiling.	11.08.01	

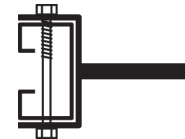
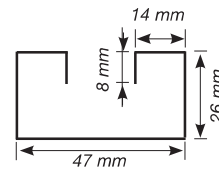

ACCESSORIES

ACCESSORIES

XA Shelf	Item no.	Type	L x D mm
The XA shelf is a strong, robust workshop shelf with an inverse lip on its front edge and a raised rear edge. Suitable brackets are type 8B, (two required).	18.01.01	XA-1000/2	1000 x 220
	20.31.01	8B bracket	
	18.02.01	XA-1000/3	1000 x 320
	20.31.02	8B bracket	
	18.03.01	XA-1000/4	1000 x 420
	20.31.03	8B bracket	
	18.04.01	XA-1000/5	1000 x 520
20.31.04	8B bracket		
XO Shelf	Item no.	Type	L x D mm
With raised front and rear edge.	18.05.01	XO-900/3	900 x 320
	20.31.02	8B bracket	
	18.06.01	XO-900/4	900 x 420
	20.31.03	8B bracket	
Shelf divider	Item no.	Type	L x D mm
Shelf divider in steel for XO shelf	18.07.01	XO-320	300 x 50
	18.08.01	XO-420	400 x 50
Instrument shelf XE-1	Item no.	Type	L x D mm
Straight shelf with fixed brackets. Suitable for power tool battery charger for instance.	18.09.02		300 x 300
A4 Paper holder	Item no.	Type	L x D x H mm
Perfect for A4 paperwork, such as job orders, information sheets, plastic wallets etc.	20.88.10		310 x 230 x 62
XH Shelf	Item no.	Type	L x D mm
Suitable for long items. A = 290 mm A = 140 mm C = 10 mm	18.10.01	XH-2000	2000 x 295
	18.10.11	XH-1500	1500 x 295
	14.04.01	XH-290 shelf divider	W: 290
	20.33.01	8D angle bracket	L: 300

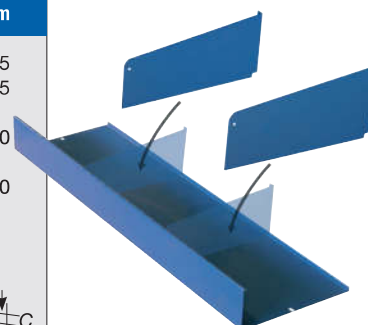
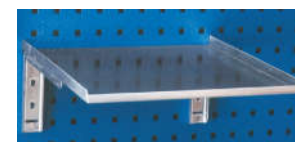
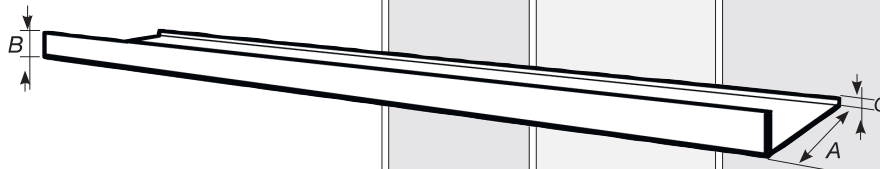

ACCESSORIES

ACCESSORIES – SPARE PARTS

Rubber wheel with C hole	Item no.	Ø in mm	
Maximum load: 80 kg/wheel Height when fitted: 135 mm. Suitable for system pillar/stand, for instance Item no. 15,16,11	13.52.02	100	
Rubber wheel, black	Item no.	Ø in mm	
125 mm wheel. Swivelling wheel Maximum load: 100 kg. Fixed wheel	13.50.04	125	
	13.50.02	125	
160 mm wheel. Swivelling wheel Maximum load: 135 kg. Fixed wheel	13.53.04	160	
	13.53.02	160	
200 mm wheel. Swivelling wheel Maximum load: 200 kg. Fixed wheel	13.54.05	200	
	13.54.06	200	
Premium wheel on ball bearings	Item no.	Ø in mm	
X-ponent's popular Swivelling wheel premium wheel which Fixed wheel allows your fully- loaded tool cart to move easily. Swivelling wheel with full brake, swing ring with double roller bearings, dust protection. Wheel body made of polyamide, Tyre: Elastic rubber, non-marking, pre- cision ball bearings. Maximum load: 300 kg/wheel Height when fitted: 200 mm	13.53.07	160	
	13.53.06	160	
Wire baskets	Item no.	mm	
Wire baskets and basket dividers are electrogalvanized. Fixings for fitting to panel included.	19.49.02	900 x 310	
	19.49.03	900 x 460	
	19.44.01	400 x 360	
	19.50.02	310	
	19.50.03	460	
19.50.01	360		
Reel winder	Item no.	Type	Diameter x width in mm
With adjustable drum diameter, from 125 to 590 mm.	20.08.03	3C	600 x 210

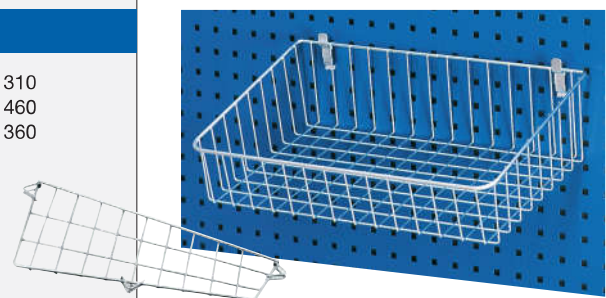

ACCESSORIES

ACCESSORIES

Folder holder X-109-1	Item no.	L x W x D mm
Designed for A4 standard folders. Can be fitted directly to tool board or side of tool cabinet or cart.	15.33.01	190 x 175 x 295
Writing shelf X-100	Item no.	Dimension in mm
Can be fitted directly to tool board and can be angled down when used as a writing shelf.	13.01.21	350 x 325
Storage bin	Item no.	L x W x D mm
Eight separate compartments for screws, nuts etc. Hangers for fitting to X-ponent panel included.	18.24.01	200 x 400 x 170

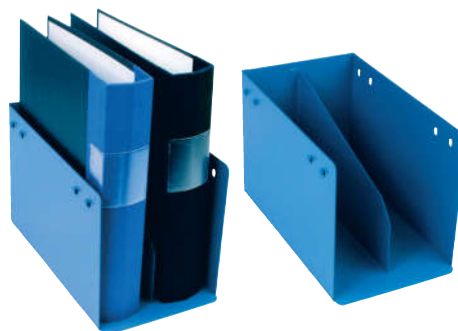

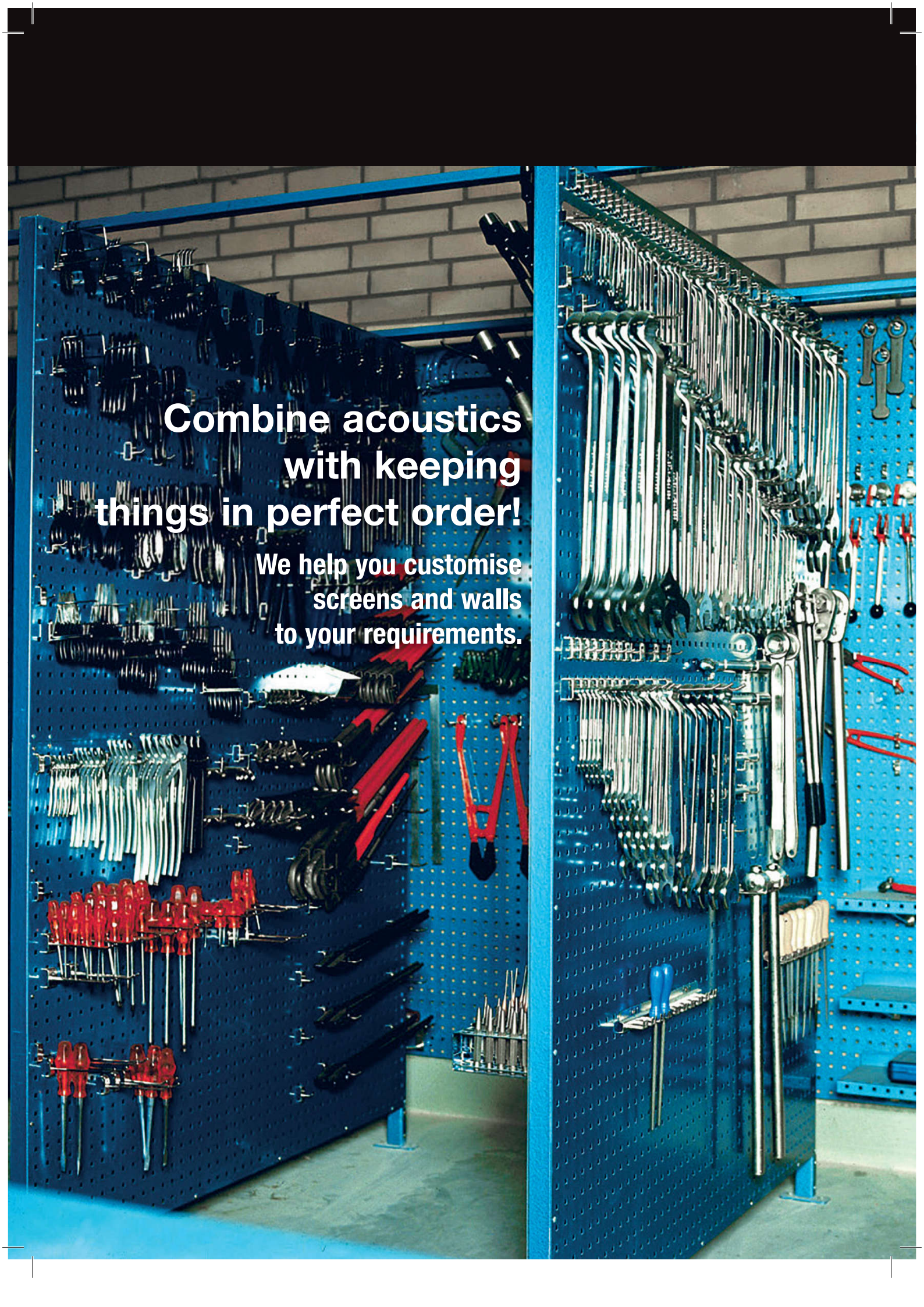

**Combine acoustics
with keeping
things in perfect order!**

**We help you customise
screens and walls
to your requirements.**

SCREENS/ACOUSTIC WALLS

X-ponent's modular screens – flexible in use.

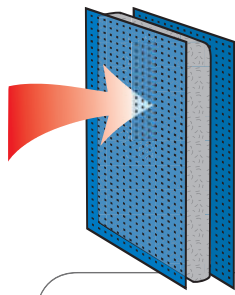

Choose acoustic walls to reduce noise – reduced sound levels and thermostability in excess of 1000°C.

Add wheels and get a mobile screen/wall.



**We help you
customise
screens and
walls to your
requirements.**

TAILORED



We help you configure and produce a suitable solution in different sections for your workplace.

BUILD IT YOURSELF

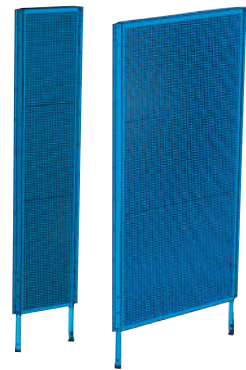

Build your workplace yourself using individual screens. For more information, see page 21.

COMPLETE WALL

Use a complete wall to screen off an area, at the same time as gaining space with lots of equipment in one spot.



WELDING CORNER

Screen off a welding corner and at the same time keep welding tools and other equipment neat and tidy. Every item has its own hook.



MODULAR SCREENS

The screens give you a big vertical storage area over a limited floor space. The walls come supplied with ready-to-assemble legs.

Hole dimensions: 9 x 9 mm, c/c distance 17 mm.

Screen/wall thickness: 53 mm.

The total wall height can be adjusted in 3 fixed stages, 1985 mm, 2090 mm and 2220 mm

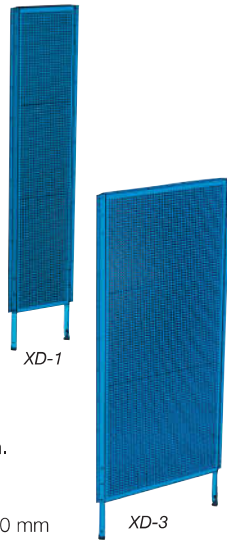

XD-1 1940 x 484 mm (H x W) without legs **Item no.** 10.88.01
 XD-3 1940 x 984 mm (H x W) without legs **Item no.** 10.89.01

MODULAR ACOUSTIC WALLS

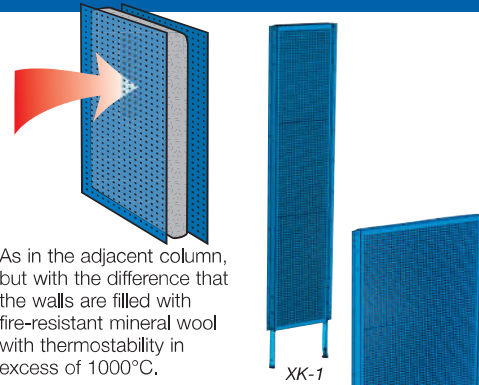

As in the adjacent column, but with the difference that the walls are filled with fire-resistant mineral wool with thermostability in excess of 1000°C.

This makes them suitable for use in welding booths and for other hot work.

The mineral wool also has a comfort layer that prevents it from causing dust. The total wall height can be adjusted in 3 fixed stages

1985 mm, 2090 mm and 2220 mm

XK-1 1940 x 484 mm (H x W) without legs **Item no.** 10.90.01
 XK-3 1940 x 984 mm (H x W) without legs **Item no.** 10.91.01

ACCESSORIES

1. C-profile 30x30 FeZn **Item no.** 10.79.01
Supplied in 2 metre lengths
2. Elevated holder for C-profile **Item no.** 10.83.01
Adjustable height (mm): 45, 150 and 280
3. Straight top bracket **Item no.** 10.85.01
For top assembly, straight, 895 mm
4. Angled top bracket 90° **Item no.** 10.84.01
For top assembly, at an angle, 478 mm
5. Angled mounting bracket for walls **Item no.** 10.81.01
90° FeZn. For assembly at an angle (supplied in pairs)
6. Straight mounting bracket FeZn **Item no.** 10.82.01
For straight assembly (supplied in pairs), 63x44 mm
7. System pillar/stand X-108 **Item no.** 10.87.01
For increased stability of free-standing walls
8. Wall leg **Item no.** 10.80.01
(2 included with each wall/screen)
9. Top bracket 3-way **Item no.** 10.86.01
For intersection assembly of 3 screens
10. System pillar/stand **Item no.** 10.87.11
L leg for assembly near a solid wall

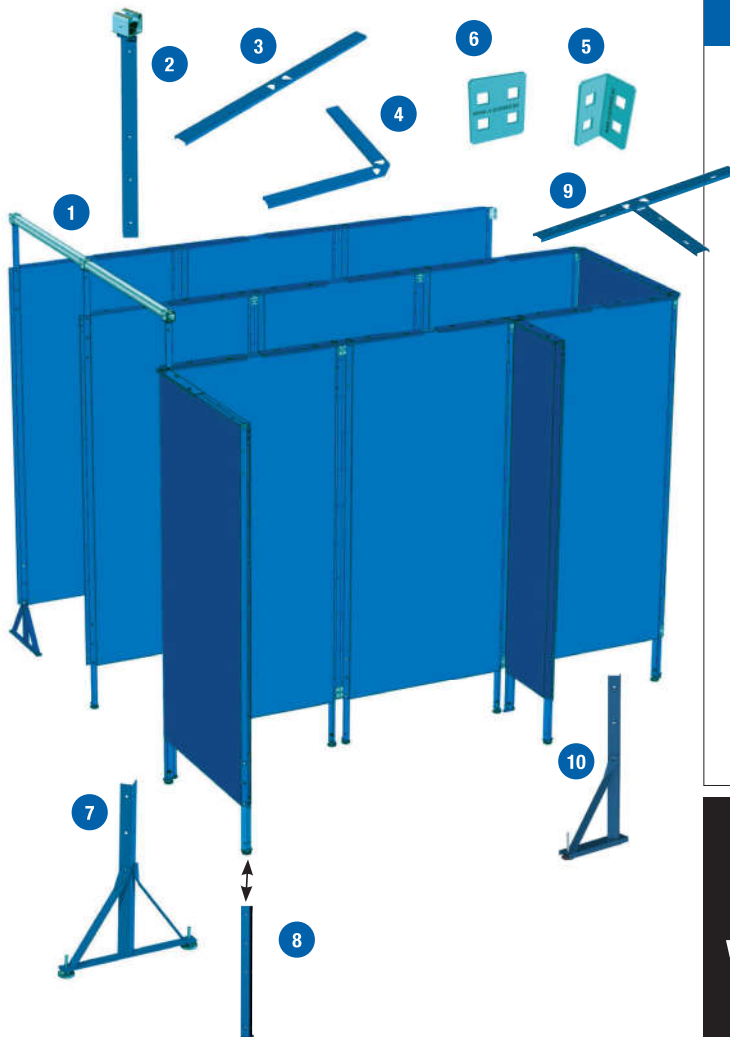

TIP!

If you give us a simple sketch of your workshop, we will outline how it could look with X-ponent's interior layouts.



**Save floor space
with X-ponent's
tool cassettes!**

Compact storage in a small area.

TOOL CASSETTES

Approximately 20 m² or more of vertical storage space on just 2 m² of floor area!

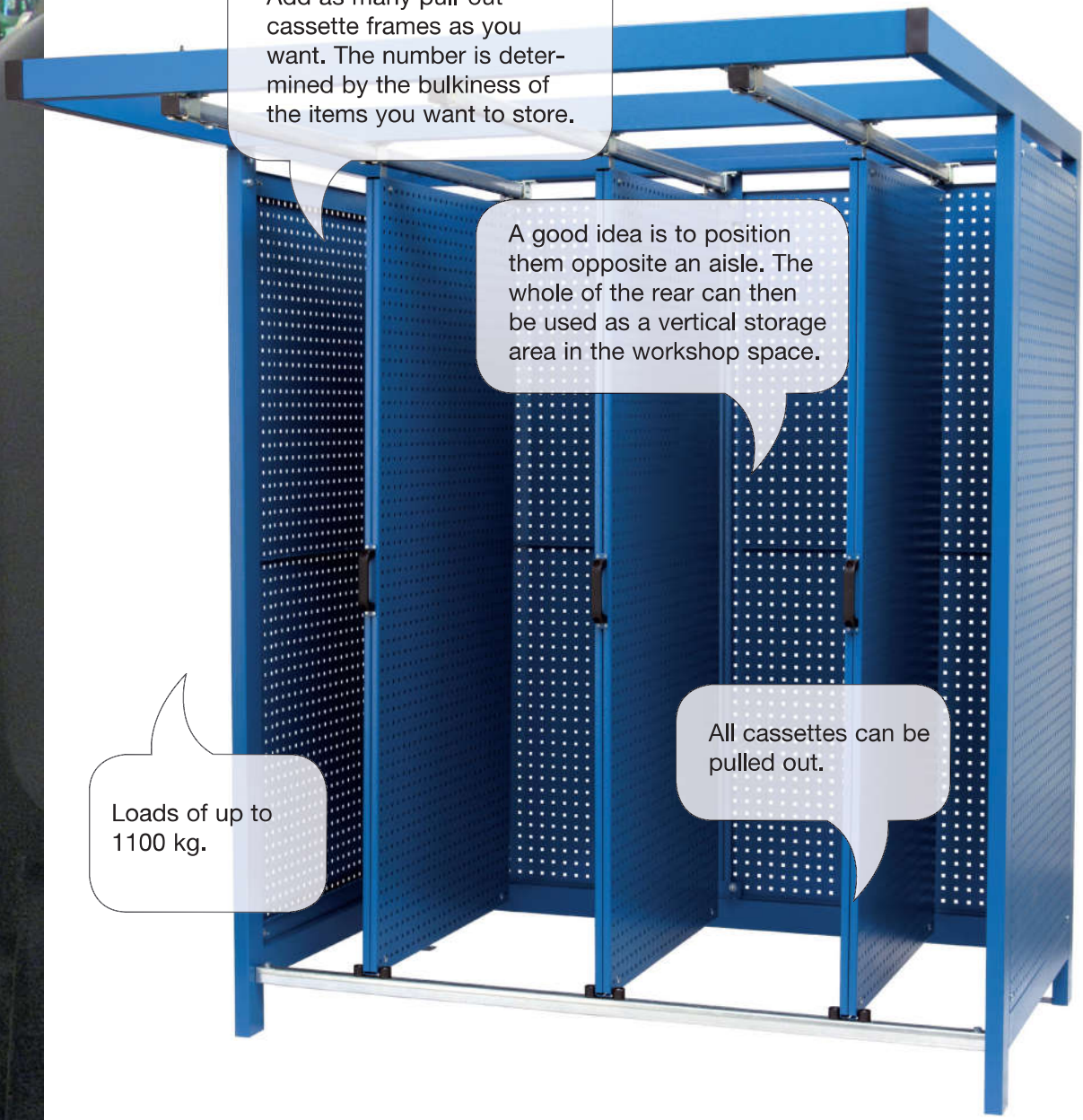

Add as many pull-out cassette frames as you want. The number is determined by the bulkiness of the items you want to store.

A good idea is to position them opposite an aisle. The whole of the rear can then be used as a vertical storage area in the workshop space.

Loads of up to 1100 kg.

All cassettes can be pulled out.

X-ponent's cassette solutions

Ready-made
solutions with lots
of storage in a
small area.

CASSETTE X-1000

A system of compact design using the minimum of floor space and giving a vertical storage area of approximately 14 m². Equipped with two pull-out frames, excluding panels. The frames are mounted laterally in your chosen location and slide in and out on runners made of 3 mm steel. Several frames can be mounted in this way.

Frames, rear stops and end pieces are designed for panels type XB-2 item no. 10.11.01.

Maximum load per frame: 100 kg.

Vertical storage of tools on end pieces and the rear is on the outside.

Vertical storage on the frames is possible on both sides.

X-1000 without panels (H x W x D):

2300 x 1050 x 1095 mm **Item no.** 15.20.01

X-1000 with panels incl. 14x XB-2:

2300 x 1050 x 1095 mm **Item no.** 15.20.03

Approximately 14 m²
or more of vertical
storage space on
just 1 m² of floor area!



CASSETTE X-2000

A system of compact design using the minimum of floor space and giving a vertical storage area of approximately 20 m².

Equipped with three pull-out frames, excluding panels. The frames are mounted laterally in your chosen location and slide in and out on runners made of 3 mm steel. Several frames can be mounted in this way.

Frames, rear stops and end pieces are designed for panels type XB-2 item no. 10.11.01.

Maximum load per frame: 100 kg.

Vertical storage of tools on end pieces and the rear is on the outside.

Vertical storage on the frames is possible on both sides.

X-2000 without panels (H x W x D):

2300 x 2050 x 1095 mm **Item no.** 15.21.01

X-2000 with panels incl. 20x XB-2:

2300 x 2050 x 1095 mm **Item no.** 15.21.03

Approximately 20 m²
or more of vertical
storage space on just
2 m² of floor area.



CASSETTE X-3005

Approximately 20 m²
or more of vertical
storage space on just
2 m² of floor area.

Stable cassette with fully moveable frames intended for heavy loads.

Maximum load per frame: 150 kg.

Total load on the cassette: 1100 kg incl. frames.

Hooks and tools can be suspended from frames (2 sides), end pieces and the rear.

X-3005 includes 2x XB-3 panels at the back:

H 2260 x W 1950 x D (top) 2000 mm **Item no.** 15.61.01

X-3005 complete set includes 10x XB-3 panels:

H 2260 x W 1950 x D (top) 2000 mm **Item no.** 15.61.03



OPTIMISE YOUR WORKPLACE WITH SMART ACCESSORIES

PANELS FOR CASSETTES

X-1000 / X-2000

Each frame accommodates: 4x XB-2
Each end piece accommodates: 2x XB-2
The rear accommodates:
X-1000 2x XB-2
X-2000 4x XB-2

XB-2 925 x 903 mm (L x W) **Item no.** 10.11.01

X-3005

Each frame accommodates: 2x XB-3
Each end piece accommodates: 1x XB-3
The rear accommodates:
X-2000 4x XB-2

XB-3 1930 x 903 mm (L x W) **Item no.** 10.13.01

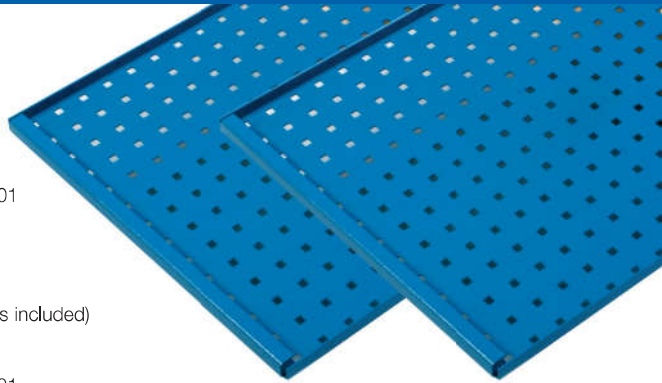

ADDITIONAL FRAMES

X-1000/X-2000 additional frame excl. panels **Item no.** 15.20.31
X-3005 additional frame incl. panels **Item no.** 15.61.31

Do you already have panels?
If not, see above (panels for cassettes).

NB

The cassettes must be secured to the floor





Everything from small compact cabinets to big ones that take a lot of filling!

WORKSHOP CABINETS

Double metal sheets in door sides and perforation on the inside. You don't need to stretch into the cabinet to get your tools.

Flat edge on the outside of the door gives a nice clean finish.

The outside of the cabinet's short sides and the back are perforated to facilitate the addition of hooks.

The short sides and back are perforated. This increases ventilation and gives you the option of attaching hooks.



CABINET X-102



Are you looking for an angled top, chemicals shelves or a height-extension piece for our cabinet series? Give us a call and we can tell you more!

FULLY WELDED

Robust tool cabinet ideal for tools that need to be locked away. Because the ends and back are both made from X-ponent steel, the cabinet can be used for vertical storage of tools both inside and out. The cabinet is made from 2 mm steel and can take very heavy loads. X-102 includes a lockable handle.



2000 x 1020 x 400 mm (H x W x D)

Item no. 14.01.01

Accessories:

Shelf X-102 incl. brackets
Set of hooks

Item no. 14.02.01

Item no. 15.80.06

CABINET X-102MAX

Are you looking for an angled top, chemicals shelves or a height-extension piece for our cabinet series? Give us a call and we can tell you more!

EXTRA DEEP

An extra big and spacious tool cabinet. Helps you organise and lock away products and tools that are on the large side. Lockable handle.



2040 x 1000 x 670 mm

Item no. 14.50.10

Accessories:

Shelf X-102MAX incl. brackets
Set of hooks

Item no. 14.50.11

Item no. 15.80.06

COMPACT CABINET X-102B

PULL-OUT PANELS

In its standard version, the cabinet is equipped with 3 pull-out panels running on robust high-quality extending slides.

Each panel can take a 150 kg load. X-102B includes a lockable handle.

Up to 7 frames can be mounted



2050 x 1000 x 820 mm (H x W x D)

Item no. 14.50.01

Accessories:

Additional pull-out panel

Item no. 15.24.41

TOOL CABINETS

TOOL CABINET X-50



Excellent as a cabinet for spanners or aerosol cans
Lockable cabinet made from strong steel.
The cabinet back and inside of the doors are made from perforated steel.

X-50 650 x 450 x 160 mm (H x W x D) **Item no.** 14.12.01

Accessories:
Shelf 430 x 110 mm (L x W) **Item no.** 14.13.01

TOOL CABINET X-103

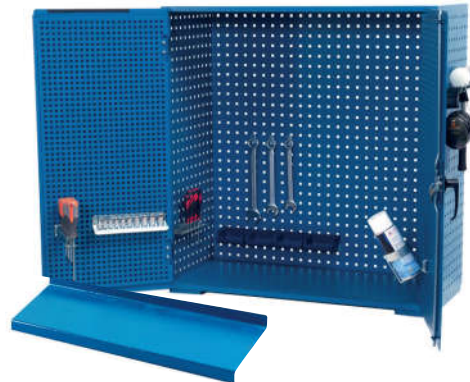

X-103 gives you lots of options for vertical storage of tools. The cabinet is made from perforated steel, including the insides of the doors.

X-103 928 x 906 x 400 mm (H x W x D) **Item no.** 14.06.01

Accessories:
XA-103 shelf 900 x 320 mm (LxW) **Item no.** 14.09.01
incl. brackets **Item no.** 15.80.07
Set of hooks **Item no.** 15.80.07

TOOL CABINET X-104



Small compact tool cabinet, lockable with integrated angled top (5S) to prevent people putting things on top of it.

X-104 928 x 473 x 280 mm (H x W x D) **Item no.** 14.08.01

Accessories:
XA-104 shelf 470 x 220 mm (L x W) **Item no.** 14.10.01
Set of hooks **Item no.** 15.80.08

TOOL CABINET X-103V



Compact cabinet for wall mounting. Aids compliance with 5S in practice, thanks to angled top and good view of tools. Perforated insides on doors, short sides and back afford extensive vertical storage options.

X-103V 900x1000/924x215 (H x W x D) **Item no.** 14.80.01

Accessories:
Set of hooks **Item no.** 15.80.07

Tool cabinet X-50



Tool cabinet X-103



Tool cabinet X-103V



Tool cabinet X-104



BIG CABINETS – FOR WHEN YOU NEED MORE SPACE

FASETT X-105 A TOOL CART



Mobile tool cart on wheels, lockable top cabinet with open bottom cabinet. Perfect where flexibility of movement is in demand. Supplied with espagnolette solution for the doors.

A shelf and drawer insert are available as accessories*.

1860 x 810 x 550 mm (H x W x D) **Item no.** 30.10.81

FASETT X-105 B HIGH CABINET



Stable, fully welded tool cabinet. Door, back and ends afford extensive vertical storage space. Angled doors mean it is deeper than conventional cabinets.

The door locking system consists of espagnolettes and cylinder lock.

Two shelves included.

An additional shelf and drawer insert are available as accessories*.

2010 x 810 x 550 mm (H x W x D) **Item no.** 30.01.01

FASETT X-105 C LOW CABINET



Smart low tool cabinet on wheels.

The cabinet's top is perfect for temporary storage. Perforated doors, ends and back ensure a big vertical storage area. Supplied with espagnolette solution.

A shelf and drawer insert are available as accessories*.

1070 x 810 x 550 mm (H x W x D) **Item no.** 30.06.01

ACCESSORIES



*) Manufactured to order.

5-drawer insert **Item no.** 30.41.01

The insert can be fitted to all Fasett cabinet versions. Complete with extending slides, 100% pull-out drawers.



*) Manufactured to order.

Shelf **Item no.** 30.39.01

Metal shelf that is screwed into the cabinet at the desired position.

Fasett is a cabinet series with additional space for those who need deeper and more spacious cabinets.

What colour do you want?

ROLL-X FOR WALL/BENCH MOUNTING

Roll-X roller front cabinet is a popular combination of a robust tool board and storage under lock and key. Neat and lockable, allowing light in, it has become a firm favourite with automotive workshops.

The cabinet comes supplied complete with lock, handle and panel and is ready for wall mounting.

Screws for mounting on a wall are NOT included.

Functional dimensions: internal depth: 146 mm

1000 x 750 x 220 mm (W x H x D) **Item no.** 30.03.02
1500 x 750 x 220 mm **Item no.** 30.03.01
2000 x 750 x 220 mm **Item no.** 30.02.01

Accessories:

Set of hooks Roll-X BASIC **Item no.** 15.80.32

Bench pillars **Item no.** 30.22.41

for fitting to X-ponent's workbenches,

Clearance: 200 mm

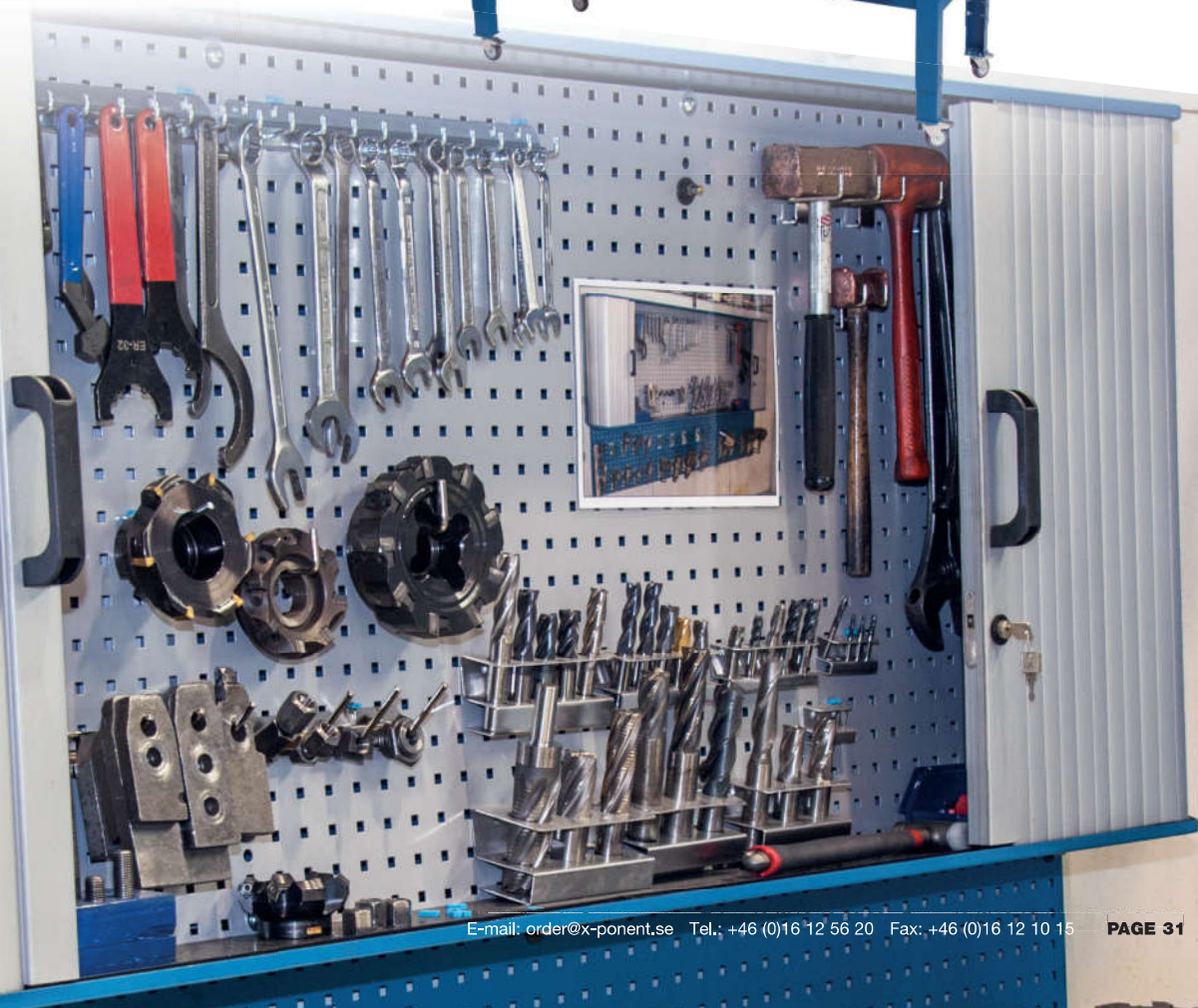

A photograph of a workshop manager standing next to a row of blue mobile tool cabinets. The cabinets are tall and have multiple drawers and doors. In the foreground, there are several large tires. The background shows a workshop environment with various tools and equipment.

Find room for everything and save time!

Our mobile tool cars have been tried and tested in car, bus and truck workshops. Suitable for use in environments where lots of mobility is needed. Stable pull-out shelf and moveable partition ensure good flexibility.

"In terms of keeping things in order, we are at a completely different level now. The guys realise we are counting on them, and they are more switched on now in terms of tidiness. The cabinets have also made them more careful with tools. They wipe them clean and there are far fewer items going missing. The cabinets still look new after 10 months and we are all very happy with them."

Patrick Johansson, workshop manager at Helmia Lastbilar AB in Karlskoga, next to two of his ten cabinets.

TOOL CARTS/WORKSHOP TROLLEYS

“We save on average 15 min per diagnostics job using the new cabinets with integrated computer”

Per-Åke Hansson, Service Manager at Volvo Truck Center in Sollentuna



What do you need to hang up? The cabinet is fully compatible with one of Europe's biggest ranges of hooks.

A new way of working in the workshop. Tool cart with integrated monitor and keyboard on the rear.

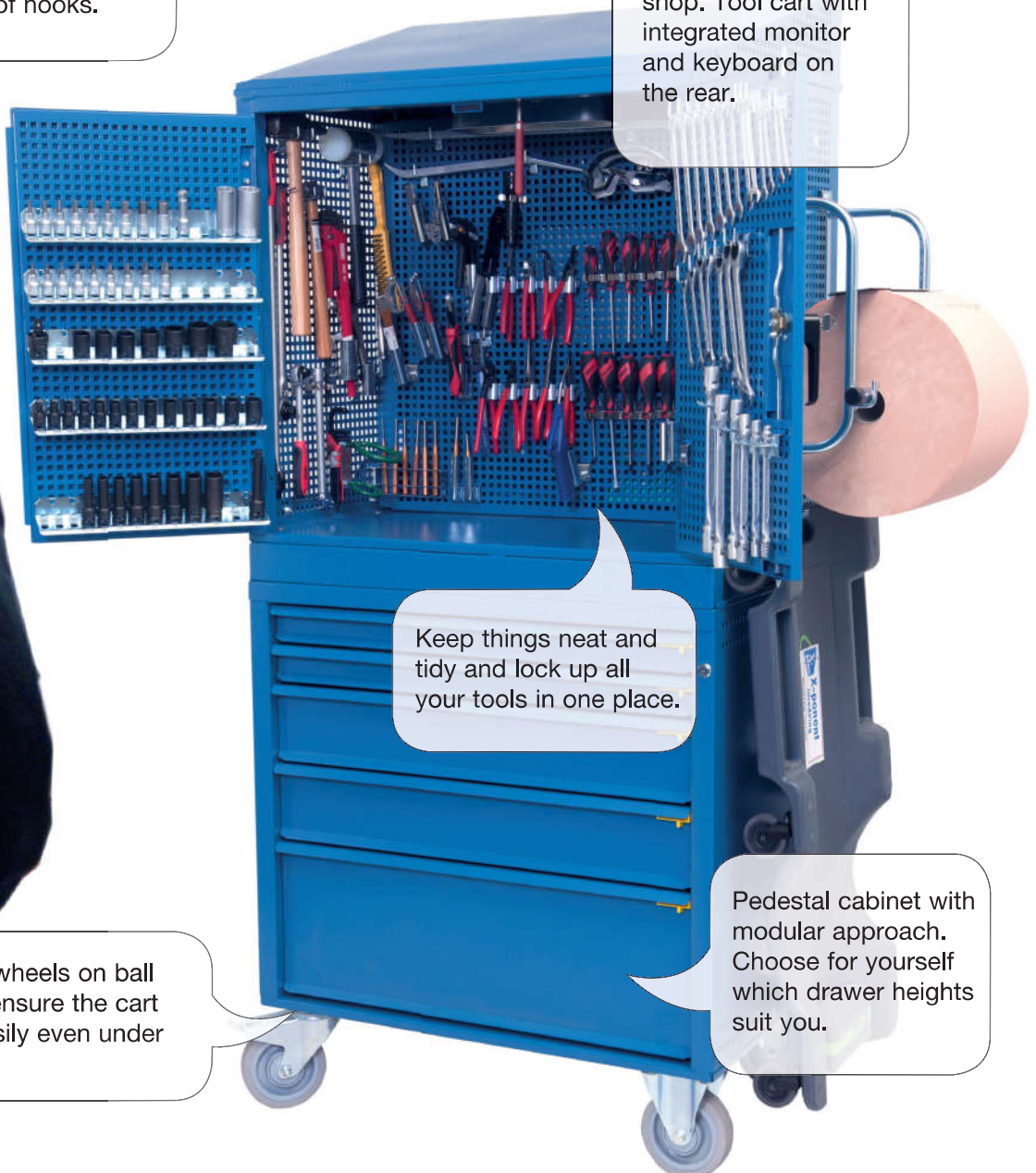

Keep things neat and tidy and lock up all your tools in one place.

Premium wheels on ball bearings ensure the cart moves easily even under big loads.

Pedestal cabinet with modular approach. Choose for yourself which drawer heights suit you.

TOOL CART SA-2

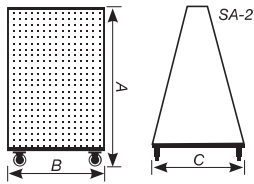

A robust and sturdy tool cart with big vertical storage area, approx. 3 m² in standard version.

Supplied with:
2 swivelling wheels with brakes
2 fixed rubber wheels (wheel diameter 125 mm)
Supplied with handle.

If you require other panel or wheel dimensions, contact us for a quotation.

A x B x C
1660 x 1000 x 520 mm **Item no.** 13.05.01

TOOL CART DAN-X

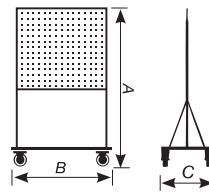

Would you like a bigger or smaller cart? No problem. This cart has two standard tool panels (model XB): replace them with the dimensions you require.

The mobile tool panel with lockable wheels made from rubber 100 mm.
Panel dimensions: 925 x 903 mm.
Dimension A indicates pillar height.
Height-adjustable panel. Supplied with handle.

A x B x C
1370 x 910 x 500 mm **Item no.** 13.28.01

TOOL CART SB-2

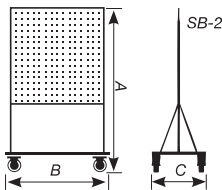

Would you like a bigger or smaller cart? No problem. Choose a dimension that suits you.

Practical tool cart, ideal for workshop use. Stable design and easy to transport.
2 panels of XB-2 type as standard.
Supplied with 2 swivelling wheels with brakes and 2 fixed rubber wheels. Wheel diameter 125 mm.
Dimension A indicates pillar height. Height-adjustable panel.

A x B x C
1430 x 1000 x 520 mm **Item no.** 13.07.01

TOOL CART SB-3

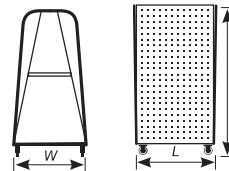

Fully welded and robust, but still easy to handle, with strong tubular handle and premium 160 mm diameter wheels on ball bearings, making it easy to move the cart even with heavy loads. The cart also has a fixed shelf. Supplied with 2 swivelling wheels with brakes and 2 fixed rubber wheels.

H x L x W
1620 x 1000 x 590 mm **Item no.** 13.09.01

WORKSHOP TROLLEY X-103H

Medium-sized tool cart specially equipped with 3-drawer pedestal cabinet. Drawer height: 1x50, 1x100, 1x150 mm
Pull-out shelf, fixed shelf, height-extension piece and 125 mm rubber wheels.

The cabinet has perforated ends, back and door insides, giving a total vertical storage space within the cabinet of more than 2 m².

Tool cabinet: H 928 x W 906 x D 400 mm.
H: 1800 mm **Item no.** 13.11.81
Set of hooks X-103 **Item no.** 15.80.07



WORKSHOP TROLLEY X-103K

Medium-sized tool cart. Pull-out shelf, fixed shelf, height-extension piece and 125 mm rubber wheels.

The cabinet has perforated ends, back and door insides, giving a total vertical storage space within the cabinet of more than 2 m².

Tool cabinet: H 928 x W 906 x D 400 mm.
H: 1800 mm **Item no.** 13.10.81
Set of hooks X-103 **Item no.** 15.80.07



TOOL CART X-PO-601

Flexible service cart for e.g. laptop, diagnostics equipment and spare parts.

With three shelves and vertical storage rails on three sides, it offers flexibility in use.

Find the right hook in our extensive range and you can hang most things on the cart. Can take heavy loads.

Wheel diameter: 100 mm, all wheels swivel and have a brake.

A detachable ribbed rubber mat comes supplied for the top shelf.

Work surface 550x550 mm, the cart can also be adjusted within a height range of 854–990 mm.



- Roll cart X-PO 601 complete as in the picture **Item no.** 30.10.10
- Roll cart X-PO 601 **Item no.** 30.11.11
- Drawer 150 mm **Item no.** 30.10.06
- Back panel 445 x 500 mm **Item no.** 30.10.07
- Set of hooks **Item no.** 15.80.24

PEDESTAL CABINET TROLLEY X-TC

Roll cart/Pedestal cabinet trolley X-TC is a compact 5-drawer workshop pedestal cabinet that combines storage with a set-down table. The compact design means the pedestal cabinet can easily be rolled under a workbench.

Supplied as standard with ribbed rubber mat and two handles.

Drawer pedestal cabinet fitted with central locking as well as individual drawer bolts. Drawer height 3 x 100, 2 x 150 mm

Pedestal cabinet trolley: H 826 x W 800 x D 530 mm



Pedestal cabinet trolley X-TC **Item no.** 13.40.34

ROLL CART X-RBP AND X-RBT



X-RBP



X-RBT



X-RBT with options

Easily manoeuvred roll cart with 5-drawer lockable pedestal cabinet and three vertical storage sides. Premium 160 mm wheels on ball bearings mean you can load this cart with as much as it will take and it will still move easily.

Can be combined with XB panel and one pair of VTS pillars.

Each pedestal cabinet comes with 5 drawers, 140 mm high, as standard. The pedestal cabinet is also available with 70 or 280 mm drawers.

Call us for more information.

The drawer pedestal cabinet is fitted with central locking as well as drawer bolts on all drawers, which stops the drawers coming out when the pedestal cabinet is moved around.

- X-RBP 1045 x 915 x 600 mm (H x W x D) with rubber mat/plate **Item no.** 13.24.01
- X-RBT 1073 x 915 x 600 mm (H x W x D) with vinyl workbench top **Item no.** 13.25.01

- Accessories:**
- VTS pillars (pair) H:110 mm **Item no.** 12.03.31
 - XB-1 panel 903 x 470 mm **Item no.** 10.10.01
 - XB-2 panel 925 x 903 mm **Item no.** 10.11.01
 - Workbench top 42 mm vinyl **Item no.** 12.08.21
 - Set of hooks **Item no.** 15.80.24

WORKSHOP TROLLEYS – OUR BIGGEST TROLLEYS

WORKSHOP TROLLEY X-HU

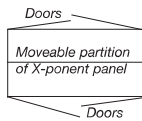

Workshop cart for a variety of uses. Stable pull-out shelf. The top cabinet has doors on both sides and a moveable partition for added flexibility. The bottom cabinet has doors on one side to form a large storage space with a moveable shelf. The cabinet comes supplied with 160 mm premium wheels on ball bearings.

1885 x 915 x 600 mm (H x W x D) **Item no.** 13.20.01

Accessories:

Electric socket 1-phase 16A	Item no. 13.22.42
Paper holder	Item no. 20.08.10
Pull-out middle shelf	Item no. 13.16.01
Angled top	Item no. 13.21.71
Set of hooks	Item no. 15.80.05



WORKSHOP TROLLEY X-HUH



Premium cart for truck workshops.

In this version of the X-HU cart, the bottom is fitted with 5 drawers each 140 mm high.

The drawer pedestal cabinet is fitted with central locking as well as drawer bolts on all drawers, which stops the drawers coming out when the pedestal cabinet is moved around.

1815 x 915 x 600 mm (H x W x D) **Item no.** 13.23.01

Accessories:

Electric socket 1-phase 16A	Item no. 13.22.42
Paper holder	Item no. 20.08.10
Pull-out middle shelf	Item no. 13.16.01
Angled top	Item no. 13.21.71
Set of hooks	Item no. 15.80.05



WORKSHOP TROLLEY X-HU103

Robust pedestal tool cabinet with a shallower top cabinet, resulting in a smart set-down and work surface in front of the top cabinet.

Top cabinet 928 x 906 x 400.

5-drawer pedestal cabinet W 915 x D 600 with central locking and individual drawer bolts. Drawer heights: 5 x 140 mm.

The pedestal cabinet trolley is fitted with 160 mm premium wheels.

2075 x 915 x 600 mm (H x W x D) **Item no.** 13.22.01

Accessories:

Electric socket 1-phase 16A	Item no. 13.22.42
Paper holder	Item no. 20.08.10
Shelf XA-103 900 x 320 mm	Item no. 14.09.01
Door stop, magnets (pair)	Item no. 20.28.00
Set of hooks	Item no. 15.80.07

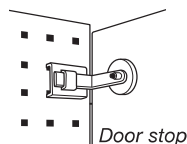

WORKSHOP TROLLEY X-TC

Robust, fully welded tool cabinet on wheels that allows a lot of light in.

Aids compliance with 5S in practice, thanks to sloping top and good view of tools.

Perforated insides on doors, ends and back afford extensive vertical storage options inside and out.

Bottom part with storage drawers that can be pulled out all the way. Between the cabinet and drawers there is also a pull-out storage shelf for e.g. a computer.

All storage areas can be locked.

160 mm premium wheels on ball bearings.

800 x 1985/1885 x 530 mm (W x H x D)

X-TC cabinet with single door and pedestal cabinet **Item no. 13.40.02**

X-TC cabinet with double doors and pedestal cabinet **Item no. 13.40.01**

X-TC cabinet with height-extension piece **Item no. 13.40.03**

Accessories:

X-TC additional pair of doors for 13.40.02 **Item no. 13.40.05**

Electric socket 1-phase 16A **Item no. 13.22.42**

Set of hooks X-TC Maxi **Item no. 15.80.50**

Set of hooks X-TC Bas **Item no. 15.80.54**



WORKSHOP TROLLEY X-TC



Roll cart/Pedestal cabinet trolley X-TC is a compact 5-drawer workshop pedestal cabinet that combines storage with a set-down table.

The compact design means the pedestal cabinet can easily be rolled under a workbench.

Supplied as standard with ribbed rubber mat and two handles.

Drawer pedestal cabinet fitted with central locking as well as individual drawer bolts.

Drawer height 3x100, 2x150 mm.

Pedestal cabinet trolley: H 826 x W 800 x D 530 mm

Pedestal cabinet trolley X-TC **Item no. 13.40.34**

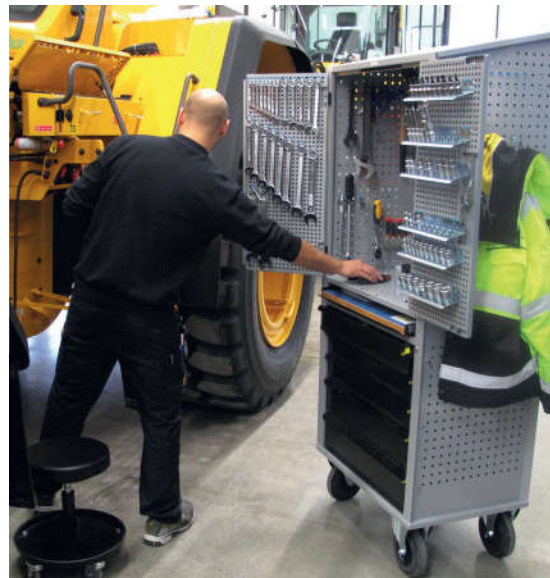

WORKSHOP TROLLEY X-PL

Compact tool cabinet with roller front door and 5-drawer pedestal cabinet.

Designed for those of you in cramped spaces who do not want to cut corners on storage and good display of tools.

Pedestal drawer cabinet with five 140 mm drawers.

Central locking and individual drawer bolts on each drawer.

Pull-out set-down shelf gives enhanced flexibility.

915 x 1915 x 410/250 mm (W x H x D) **Item no. 13.32.01**

Accessories:

Set of hooks XB-2 **Item no. 15.80.10**



A blue perforated metal board with three silver hooks of different shapes attached to it. The hooks are arranged vertically. The top hook is a long, thin, curved hook. The middle hook is a U-shaped hook. The bottom hook is a C-shaped hook. The board has a grid of rectangular holes.

Everything in its right place!

Stop having to search for tools!
With our range of hooks
– one of Europe's biggest –
getting your workplace in
order will be child's play.

HOOKS

Smart solutions save time and money! We can hang up **most things!**

Stock items or tailored to your requirements. In-house manufacture ensures high quality and short lead times. All hooks are available from stock!



SET OF HOOKS/STARTER KIT – READY-MADE SOLUTIONS

ITEM NO.	TYPE	QUANTITY
15.80.24 Set of hooks for wall panel XB-1, page 12		
Hook		
20.11.02	1	6
20.11.10	1	4
20.16.02	2	2
20.22.03	4H	4
Tool holder		
20.40.03	12-101-12	2
20.40.05	12-101-12	2
TOTAL		20

GOOD START

ITEM NO.	TYPE	QUANTITY
15.80.10 Set of hooks for wall panel XB-2, page 12		
Plastic box		
18.31.01 box	0,2 l	1
18.26.03 holder	BX-3	1
Hook		
20.11.01	1	6
20.11.06	1	2
20.13.02	1C	2
20.14.02	1D	2
20.16.02	2	3
20.16.05	2	2
20.16.07	2	2
20.18.01	3	2
20.20.06	4	1
20.22.03	4H	3
20.22.05	4H	1
Tool holder		
20.40.03	12-101-12	2
20.40.05	12-101-14	2
20.40.07	12-101-16	2
Drill/Punch stand		
20.56.03	18-9/8	1
Ring holder		
20.65.02	27/2	1
File rack		
20.67.02	29/2	1
Tube stand		
20.69.02	31/2	1
20.69.04	31/4	1
20.69.05	31/5	1
Oilcan holder		
20.71.02	33/2	1
TOTAL		41

ROBUST SET OF HOOKS

ITEM NO.	TYPE	QUANTITY
15.80.11 Set of hooks for wall panel XB-3, page 12		
Plastic box		
18.31.01 box	0,2 l	4
18.26.03 holder	BX-3	4
Hook		
20.11.01	1	10
20.11.02	1	5
20.11.06	1	2
20.13.02	1C	5
20.13.03	1C	2
20.14.02	1D	3
20.14.03	1D	3
20.16.02	2	10
20.16.04	2	4
20.16.06	2	2
20.18.01	3	2
20.20.02	4	2
20.20.05	4	2
20.22.03	4H	4
20.22.05	4H	2
Tool holder		
20.40.02	12-101-11	2
20.40.04	12-101-13	4

ITEM NO.	TYPE	QUANTITY
Tool holder		
20.40.06	12-101-15	4
20.40.09	12-101-18	1
Multi-hook		
20.52.01	4H-S	1
20.53.02	12-S	1
Drill/Punch stand		
20.56.02	18-7/10	1
Hex key stand		
20.61.01	23/1	1
Ring holder		
20.65.02	27/2	1
20.65.03	27/3	1
File rack		
20.67.02	29/2	1
Tube stand		
20.69.02	31/2	3
20.69.04	31/4	2
20.69.05	31/5	4
Oilcan holder		
20.71.02	33/2	1
TOTAL		94

15.80.02 Set of hooks for bench X-PO 1500 K page 6

ITEM NO.	TYPE	QUANTITY
Plastic box		
18.31.01 box	0,2 l	2
18.26.03 holder	BX-3	2
Hook		
20.11.02	1	10
20.13.02	1C	4
20.13.03	1C	2
Multi-holder		
20.14.10	5D	1
Hook		
20.16.03	2	10
20.16.05	2	2
20.20.01	4	2
20.20.02	4	2
20.22.03	4H	4
20.22.04	4H	2
20.22.05	4H	2
Tool holder		
20.40.02	12-101-11	4
20.40.04	12-101-13	4
20.40.06	12-101-15	4
20.40.09	12-101-18	1
Multi-hook		
20.52.01	4H-S	1
20.53.02	12-S	1
Holder		
20.56.13	type 18C	1
Hex key stand		
20.61.01	23/1	1
Ring holder		
20.65.02	27/2	2
20.65.04	27/4	2
File rack		
20.67.02	29/2	1
Tool holder with compartments		
20.68.01	30	1
Tube stand		
20.69.01	31/1	2
20.69.02	31/2	2
20.69.05	31/5	2
Oilcan holder		
20.71.03	33/3	1
Holder		
20.72.02	34B	1
TOTAL		76

15.80.03 Set of hooks for bench X-PO 2000 K, page 6

ITEM NO.	TYPE	QUANTITY
Plastic box		
18.31.01 box	0,2 l	2
18.26.03 holder	BX-3	2
Hook		
20.11.01	1	5
20.11.02	1	5
20.13.02	1C	6
20.13.03	1C	4
Multi-holder		
20.14.10	5D	1
Hook		
20.16.01	2	6
20.16.03	2	6
20.16.05	2	6
20.20.01	4	2
20.20.02	4	2
20.22.03	4H	4
20.22.04	4H	4
20.22.05	4H	5
Tool holder		
20.40.02	12-101-11	5
20.40.04	12-101-13	5
20.40.06	12-101-3	5
20.40.09	12-101-5	2
Multi-hook		
20.50.01	1S	1
20.52.01	4H-S	1
20.53.02	12-S	1
Holder		
20.56.13	type 18C	1
Hex key stand		
20.61.01	23/1	1
Ring holder		
20.65.02	27/2	2
20.65.04	27/4	2
File rack		
20.67.02	29/2	1
Tool holder with compartments		
20.68.01	30	1
Tube stand		
20.69.01	31/1	2
20.69.02	31/2	2
20.69.05	31/5	4
20.69.06	31/6	2
Oilcan holder		
20.71.03	33/3	1
Holder		
20.72.02	34B	1
TOTAL		100

15.80.05 Set of hooks for cabinet X-HU, page 36

ITEM NO.	TYPE	QUANTITY
Plastic box		
18.31.01 box	0,2 l	2
18.26.03 holder	BX-3	2
Hook		
20.11.02	1	10
20.13.01	1C	10
20.13.02	1C	10
20.14.02	1D	3
20.14.03	1D	3
20.16.03	2	10
20.16.05	2	5
20.16.07	2	5
20.22.04	4H	10
20.22.05	4H	2



SET OF HOOKS/STARTER KIT – READY-MADE SOLUTIONS

ITEM NO.	TYPE	QUANTITY
Tool holder		
20.40.03	12-101-12	2
20.40.04	12-101-13	2
20.40.05	12-101-14	2
20.40.06	12-101-15	2
Multi-hook		
20.52.01	4H-S	1
20.53.02	12-S	1
Ring holder		
20.64.03	26/3	1
20.64.05	26/5	1
Socket rack		
20.66.07	28B/1	1
20.66.08	28B/2	1
File rack		
20.67.02	29/2	1
Tool holder with compartments		
20.68.01	30	1
Tube stand		
20.69.03	31/3	2
20.69.04	31/4	2
20.69.05	31/5	2
Oilcan holder		
20.71.02	33/2	1
Drill stand		
20.77.01	40	1
TOTAL		96
15.80.06 Set of hooks for cabinet X-102, page 28		
Hook		
20.11.01	1	5
20.11.02	1	10
20.11.03	1	10
20.11.10	1	5
20.13.01	1C	5
20.13.02	1C	5
20.13.03	1C	5
20.14.02	1D	5
20.14.03	1D	5
20.16.01	2	4
20.16.02	2	4
20.16.03	2	4
20.16.04	2	4
20.16.05	2	4
20.16.07	2	4
20.16.08	2	4
20.20.04	4	4
20.20.05	4	4
20.20.06	4	4
20.22.01	4H	2
20.22.03	4H	5
20.22.04	4H	5
20.22.05	4H	5
20.22.06	4H	5
Tool holder		
20.40.02	12-101-11	2
20.40.03	12-101-12	2
20.40.04	12-101-13	2
20.40.05	12-101-14	2
20.40.06	12-101-15	2
Multi-hook		
20.50.01	1S	1
20.52.01	4H-S	1
20.54.03	S-12-0B	1
Drill/Punch stand		
20.56.05	18-16/6	2
20.56.06	18-16/6	2
20.56.07	18-19/5	2



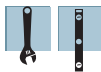

ITEM NO.	TYPE	QUANTITY
File rack		
20.67.02	29/2	1
Tube stand		
20.69.02	31/2	2
20.69.03	31/3	2
20.69.04	31/4	2
20.69.05	31/5	2
Oilcan holder		
20.71.03	33/3	1
Milling cutter stand		
20.81.02	44/2	1
20.81.03	44/3	1
20.81.04	44/4	1
20.81.05	44/5	1
20.81.06	44/6	1
Holder		
20.83.0146/1 Taper adapter 1 series		2
20.83.0246/2 Taper adapter 2 series		2
20.83.0346/3 Taper adapter 3 series		2
20.83.04 46/4 Taper adapter 4 series		2
TOTAL		160
15.80.07 Set of hooks for cabinet X-103, page 29		
Plastic box		
18.31.01 box	0,2 l	3
18.26.03 holder	BX-3	3
Hook		
20.11.01	1	4
20.11.02	1	4
20.11.03	1	4
20.13.01	1C	4
20.13.02	1C	4
20.14.02	1D	3
20.14.03	1D	3
20.16.02	2	4
20.16.03	2	4
20.16.04	2	4
20.16.07	2	4
20.22.03	4H	4
20.22.04	4H	4
20.22.05	4H	4
Tool holder		
20.40.03	12-101-12	2
20.40.04	12-101-13	2
20.40.05	12-101-14	2
20.40.06	12-101-15	2
Multi-hook		
20.52.01	4H-S	1
Drill/Punch stand		
20.56.06	18-16/6	1
Ring holder		
20.64.02	26/2	1
20.65.03	27/3	1
Socket rack		
20.66.03	28/3	1
File rack		
20.67.02	29/2	1
Tube stand		
20.69.02	31/2	2
20.69.04	31/4	2
Drill stand		
20.78.01	41	1
Holder		
20.83.03	46/3	1
TOTAL		82

ITEM NO.	TYPE	QUANTITY
15.80.08 Set of hooks for cabinet X-104, page 29		
Plastic box		
18.31.01 box	0,2 l	2
18.26.03 holder	BX-3	2
Hook		
20.11.01	1	4
20.11.02	1	4
20.13.01	1C	4
20.13.02	1C	4
20.14.02	1D	2
20.14.03	1D	2
20.16.02	2	4
20.16.04	2	4
20.16.07	2	4
20.22.03	4H	4
20.22.05	4H	4
Tool holder		
20.40.03	12-101-12	2
20.40.04	12-101-13	2
20.40.05	12-101-14	2
20.40.06	12-101-15	2
Multi-hook		
20.52.01	4H-S	1
Ring holder		
20.64.02	26/2	1
20.65.03	27/3	1
Socket rack		
20.66.03	28/3	1
File rack		
20.67.02	29/2	1
Tube stand		
20.69.02	31/2	2
20.69.04	31/4	2
Drill stand		
20.77.01	40	1
TOTAL		62
15.80.32 Set of hooks Roll-X basic, page 31		
Hook		
20.11.02	1	30
20.11.03	1	20
20.20.06	4	1
20.22.03	4H	5
20.22.04	4H	5
Tool holder		
20.40.04	12-101/13	5
Socket rack		
20.66.04	28/4	1
File rack		
20.67.02	29/2	1
Tube stand		
20.69.02	31/5	1
Oilcan holder		
20.71.03	33/3	1
TOTAL		70

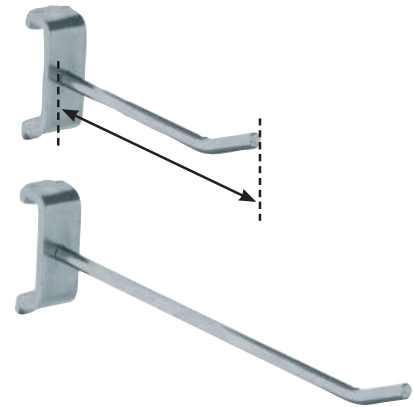
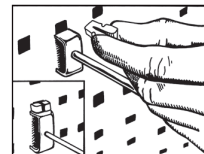
VERTICAL STORAGE SYSTEM – ONE OF EUROPE'S BIGGEST RANGES

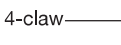

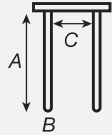

Decal/label set for hand tools BASIC	Item no.	
Every item has its own hook! Tool decals save time and are a natural step towards keeping everything absolutely neat and tidy! Set contains templates for basic tools.	50.28.01	
Set of hooks to match decal set BASIC	Item no.	
Hooks and holders designed to match decal/label set 50.28.01	15.80.55	
Additional locking device, pack of 100	Item no.	Colour
Locking devices included for all vertical storage systems.	20.10.00	Blue 4 mm
Single hook 1	Item no.	Length/thickness in mm
 <p>Single hook 1 is our best seller and is the basic hook that allows you to hang up light and medium-weight tools and products, such as screwdrivers etc.</p>	20.11.01	25 x 4
	20.11.02	50 x 4
	20.11.03	75 x 4
	20.11.04	125 x 4
	20.11.06	100 x 4
	20.11.07	150 x 4
	20.11.08	200 x 4
	20.11.09	50 x 6
	20.11.10	100 x 6
	20.11.11	150 x 6
	20.11.12	200 x 6
	20.11.13	300 x 6
	20.11.14	50 x 8
	20.11.15	100 x 8
	20.11.16	200 x 8
20.11.17	300 x 8	
20.11.18	400 x 8	
Single hook 1B	Item no.	Length/thickness in mm
 <p>Extra strong for heavy loads.</p>	20.12.02	100 x 10
	20.12.03	150 x 10
	20.12.04	200 x 10
Single hook 1C	Item no.	Length/thickness in mm
Hook ideally suited to e.g. shelves of all dimensions.	20.13.01	30 x 4
	20.13.02	50 x 4
	20.13.03	75 x 6
	20.13.04	125 x 8
Clamp hook 1D	Item no.	A x B mm
 <p>Ideal hook for pliers, standard spanners, etc. 4 mm steel wire.</p>	20.14.01	25 x 17
	20.14.02	35 x 17
	20.14.03	45 x 17
	20.14.04	55 x 17
	20.14.05	65 x 18
	20.14.06	75 x 18
Multi-holder 5D	Item no.	
 <p>For pliers. Length 185 mm.</p>	20.14.10	internal Ø 22



Angled hook 2	Item no.	Length x thickness in mm
 <p>An extremely practical hook for workshop use. These strong hooks can also hold lightweight rods and bars.</p> <p>4-claw </p>	20.16.01	10 x 4
	20.16.02	15 x 4
	20.16.03	20 x 4
	20.16.04	25 x 4
	20.16.05	30 x 4
	20.16.06	30 x 6
	20.16.07	65 x 6
	20.16.08	140 x 6
	20.16.09	70 x 8
	20.16.10	140 x 8
Adjustable angled hook 2B	Item no.	Length x thickness in mm
 <p>Sometimes the pitch of the angle needs changing. The 2B hook meets the need for lighter loads.</p>	20.17.01	65–110 x 6
	20.17.02	110–180 x 6
Wide hook 3	Item no.	mm (maximum width)
 <p>T=5 mm</p>	20.18.01	40
	20.18.02	60
	20.18.03	80
	20.18.04	100
	20.18.05	150
Wide hook 3B	Item no.	Diameter
 <p>T=2 mm</p>	20.19.01	Ø 15
	20.19.03	Ø 25
	20.19.05	Ø 35
Double hook 4	Item no.	A x B x C mm
 <p>With parallel pins.</p>	20.20.01	35 x 4 x 10
	20.20.02	35 x 4 x 15
	20.20.03	35 x 4 x 25
	20.20.04	75 x 4 x 10
	20.20.05	75 x 4 x 15
	20.20.06	75 x 4 x 25
	20.20.07	100 x 4 x 25
	20.20.08	150 x 4 x 8
	20.20.09	150 x 4 x 10
	20.20.10	150 x 4 x 15
	20.20.11	150 x 4 x 20
	20.20.12	200 x 4 x 25
	20.20.13	400 x 8 x 30
		



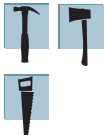

VERTICAL STORAGE SYSTEM – ONE OF EUROPE'S BIGGEST RANGES

Double hook 4B	Item no.	A x B x C mm
Closed double hook with parallel pins.	20.21.00 20.21.01 20.21.02	100 x 5 x 28 200 x 5 x 28 300 x 5 x 28
Double hook 4C	Item no.	A x B x C mm
Closed upward-angled double hook with parallel pins. Designed for e.g. clogs, rubber gloves, etc.	20.21.20	160 x 4 x 30
Cable holder 4D	Item no.	
	20.21.08 20.21.09	L: 105 single L: 170 double
Double hook 4H	Item no.	A x B mm
 With angled pins.	20.22.01 20.22.02 20.22.03 20.22.04 20.22.05 20.22.06 20.22.07 20.22.08	10 x 30 20 x 20 30 x 30 30 x 45 45 x 45 45 x 60 60 x 60 60 x 75
4H Special double hook 4H	Item no.	A x B mm
 Steel wire Ø 8 mm.	20.23.01 20.23.02	45 x 40 70 x 50
Holder 5C	Item no.	
 For chain saws.	20.24.03	Length: 160
Holder 5B	Item no.	
 For angle grinders. Steel wire Ø 8 mm.	20.24.04	Length: 200



VERTICAL STORAGE SYSTEM – ONE OF EUROPE'S BIGGEST RANGES



Holder 6C	Item no.	mm
 For safety helmets.	20.27.01	Ø 120
U-bracket hook 7	Item no.	mm
 For holding shanks etc. in supply stores, ironmonger's etc. Steel wire Ø 8 mm.	20.28.01 20.28.02	200 x 130 300 x 130
Straight bracket, model 8	Item no.	mm
Material dimensions: 8 x 15 mm. Bracket for shelves XA and XO. Can also be used as a bracket for supporting heavier loads.	20.29.01 20.29.02 20.29.03 20.29.04	214 314 414 514
Angle bracket 8A 30°	Item no.	mm
Material dimensions: 8 x 15 mm.	20.30.01 20.30.02 20.30.03	214 314 414
Steel wire bracket 8B	Item no.	mm
Straight model. Material dimensions: Ø 8 mm.	20.31.01 20.31.02 20.31.03 20.31.04	214 314 414 514
Angle bracket 8C	Item no.	mm
 Material dimensions: 8 x 15 mm. Ideal storage bracket that can take heavy loads of e.g. bar and rod material etc.	20.32.01 20.32.02 20.32.03 20.32.04	125 x 60 200 x 125 300 x 135 400 x 250
Steel wire bracket 8D	Item no.	mm
Material dimensions: Ø 8 mm.	20.33.01 20.33.02	300 x 100 400 x 100
Lamp bracket 8R	Item no.	mm
Material dimensions: 8 x 15 mm. Special bracket for fitting light bars where goods are displayed on X-ponent panels.	20.34.01 20.34.02	Ø 6 mm 375 Ø 6 mm 475
Angle bracket 9	Item no.	mm
Material dimensions: Ø 8 mm.	20.35.01 20.35.02	200 x 100 300 x 150



VERTICAL STORAGE SYSTEM – ONE OF EUROPE'S BIGGEST RANGES

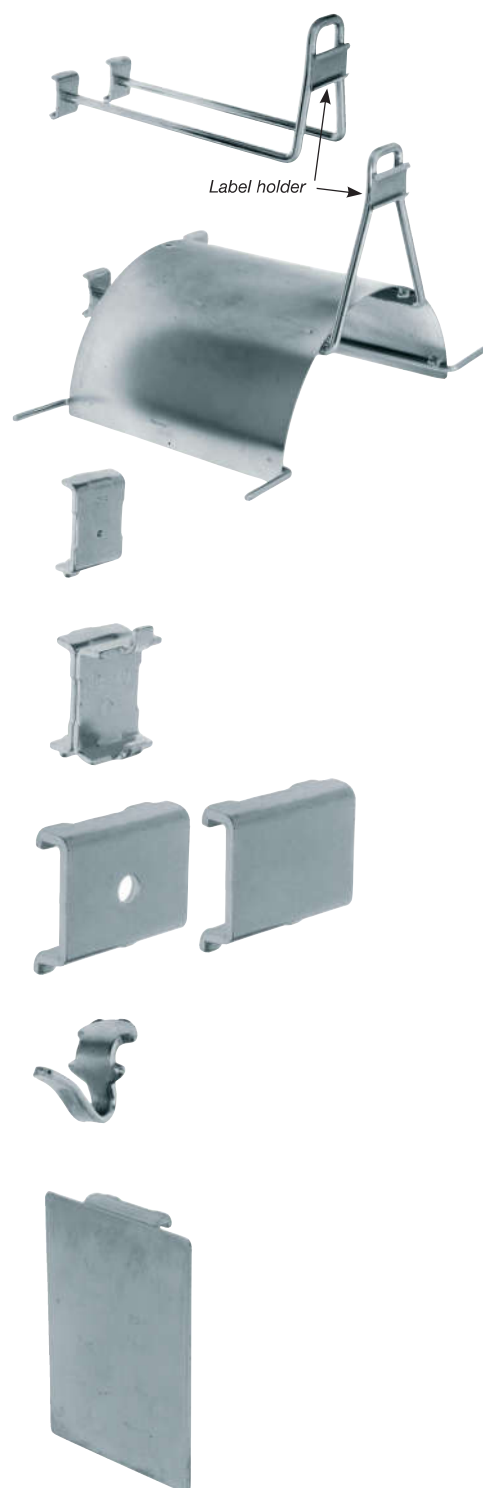

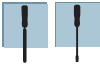
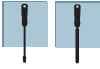
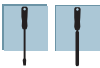
Cable/belt holder 11-K	Item no.	Length x pin spacing
For V-belts/electric cables etc. Material dimensions: Ø 8 mm.	20.36.01	125 x 68
	20.36.02	250 x 68
	20.36.03	125 x 136
	20.36.04	250 x 136
Sheet metal drum 11-K4	Item no.	Width
Sheet metal drum with holder. Complete. Intended for easily-damaged V-belts, brake cable, etc.	20.37.01	245
Hook base 12	Item no.	Width mm
With threaded hole.	20.38.01	15 M 3
	20.38.02	25 M 3
	20.38.03	40 M 4
	20.38.04	50 M 4
Double hook base 12A	Item no.	Width mm
For easy fitting of e.g. X-ponent panel to an X-1 or X-2 rail.	20.38.05	25
Hook base BRX-18	Item no.	
4-claw base. Hole dimensions: Ø 8 mm. 50 x 38 mm. Metal: 3 mm.	20.87.18	with hole, treated
	20.87.22	without hole, untreated
	20.87.23	without hole, treated
	20.87.24	with hole, untreated
Hook 12B	Item no.	Width mm
The hook only fills one hole and is therefore ideal on a horizontal X-1 rail.	20.39.01	25
Plain plate 12C	Item no.	mm
For e.g. electric sockets. Useful as a flexible holder for e.g. a lamp with magnetic base. Also suitable for use in training situa- tions for instruction in the assembly of electrical/pneumatic components.	20.39.02	80 x 110
	20.39.03	100 x 130
	20.39.04	120 x 150
	20.39.05	150 x 180



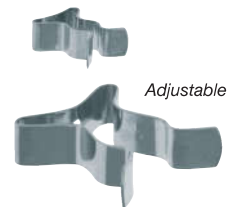
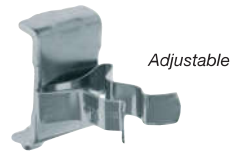

Tool holder 12-101-	Item no.	Type For Ø mtrl. in mm	
 Made from tempered	20.40.01	-10	6
	20.40.02	-11	9
	20.40.03	-12	12
	20.40.04	-13	15
	20.40.05	-14	18
	20.40.06	-15	25
	20.40.07	-16	28
	20.40.08	-17	31
	20.40.09	-18	37
	20.40.10	-19	50
Adjustable tool holder 12-	Item no.	Type Grip width in mm	
 With matching base and adjusting screw.	20.41.01	28	4-10
	20.41.02	88	22-31
	20.41.03	0B	8-19
	20.41.04	1B	16-32
	20.41.05	2B	19-45
Paper holder/clip 51	Item no.	Width mm	
	20.42.02	30	
Tool holder 101-	Item no.	Type For Ø mtrl. in mm	
 Without panel base. Made from tempered steel. Supplied in packs of 100.	20.43.01	-10	6
	20.43.02	-11	9
	20.43.03	-12	12
	20.43.04	-13	15
	20.43.05	-14	18
	20.43.06	-15	25
	20.43.07	-16	28
	20.43.08	-17	31
	20.43.09	-18	37
	20.43.10	-19	50
Tool holder	Item no.	Type Grip width in mm	
 Without panel base. Grip width can be adjusted by tightening the securing screw.  Supplied in packs of 100.	20.44.01	28	4-10
	20.44.02	88	22-31
	20.44.03	0B	8-19
	20.44.04	1B	16-32
	20.44.05	2B	19-45



VERTICAL STORAGE SYSTEM – ONE OF EUROPE'S BIGGEST RANGES

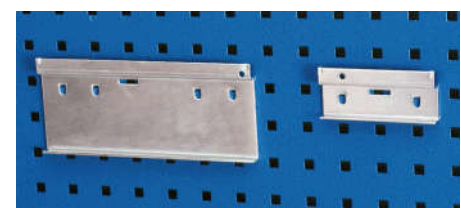

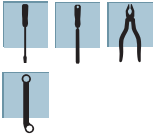
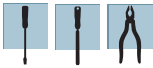
Hook 13	Item no.	Dim. in mm
For tool tags. Blank tool tags.	20.11.01 20.46.02	25 x 4 Ø 26
Hose holder KAB-X 16	Item no.	Drum diam. in mm
 A robust holder for hoses and cables. For mounting on X-ponent panel.	20.48.01	140 x 250
Tensioning straps 15	Item no.	Length in mm
 Complete. For e.g. hand-held fire extinguisher etc. Distance from panel: 150 mm.	20.49.04 20.49.05	185 280
 For tools etc. that are positioned on an X-ponent panel in a service vehicle, vessel or similar.	20.49.01 20.49.02 20.49.03 20.49.06	185 280 200 185
Snabb-X Tensioning strap with extra large handle for rapid and easy removal of the strap even if you are wearing gloves.	20.49.00	200
Rubber straps 15 Only rubber strap in natural rubber. Temperature range -60 to +100°.	20.49.07 20.49.08 20.49.09	185 280 200
Plastic boxes and holders	Item no.	L x W x H mm
Plastic box in impact-resistant polypropylene 0.2 litres	18.31.01	96 x 105 x 45
Plastic box in impact-resistant polypropylene 1.0 litre	18.31.02	170 x 105 x 75
Holder for 1 plastic box:	18.26.03	110 x 47
18.31.01 or 18.31.02	18.32.01	430 x 47
Holder for 4 plastic boxes:	18.31.03	250 x 148 x 130
18.31.01 or 18.31.02	18.32.02	212 x 95
18.32.04	18.32.04	400 x 95
Plastic box in impact-resistant polypropylene 3.7 litres	20.46.06	
Holder for 1 plastic box: 18.31.03		
Holder for 2 plastic boxes: 18.31.03		
Locking hook for plastic box. Holds the plastic box in place in e.g. vehicles or on carts.		



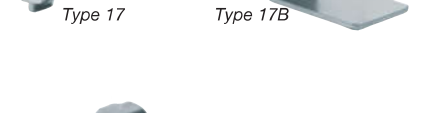
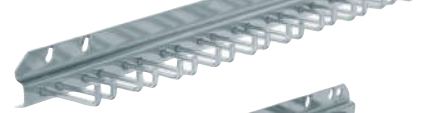
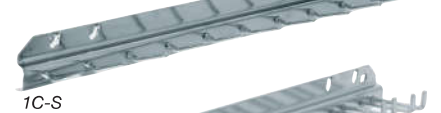
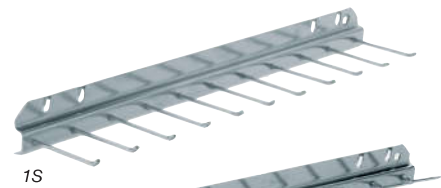



Multi-hook		Item no.	mm	
 <p>1S With 11 pins. Length 400 mm.</p> <p>1C-S With upward angled pins. Length 400 mm.</p> <p>4H-S With 10 double hooks. Length 400 mm.</p> <p>With 11 double hooks. Length 400 mm.</p> <p>12-S With 11 pins. Length 400 mm.</p> <p>S-12-1S Multi-hook/clip Length 400 mm.</p>		20.50.01	25 x 3,5	
		20.50.02	50 x 3,5	
		20.50.03	75 x 3,5	
		20.51.01	30 x 3,5	pins 11
		20.51.02	50 x 4,5	9
		20.51.03	75 x 6	7
		20.52.01	30 x 10	
		20.52.02	50 x 10	
		20.52.11	100 x 5	
		20.53.01		Angle spacing in mm
	20.53.02		10	
	20.53.03		15	
	20.53.03		25	
	20.50.05		Pin dim. 50 x 4,5 Clips for material Ø 18 mm.	
Multi-holder S-12		Item no.	Type Grip width in mm	
 <p>With 10 adjustable tool holders per rail. Length 400 mm.</p>	20.54.01	28	4–10	
	20.54.02	88	22–31	
	20.54.03	0B	8–19	
L-profile holder 17		Item no.	Hole in mm	
 <p>With hole for holding various tools.</p> <p>17 B</p>	20.55.01	Ø 5		
	20.55.02	Ø 10		
	20.55.03	Ø 15		
	20.55.04	Ø 15		
Holder 17C		Item no.	Hole in mm	
Suitable for e.g. quick-releases.		20.55.07	Ø 12	

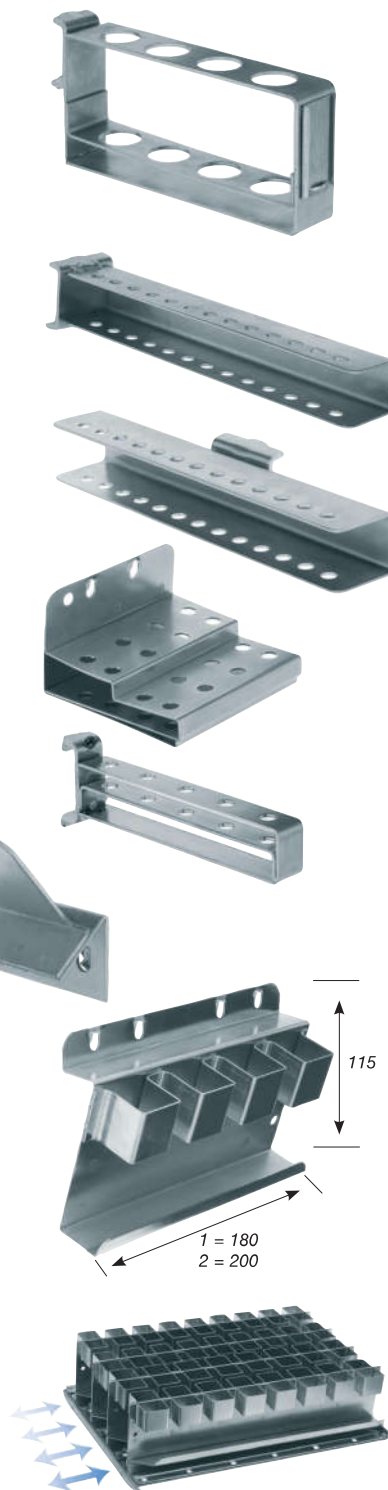

VERTICAL STORAGE SYSTEM – ONE OF EUROPE'S BIGGEST RANGES

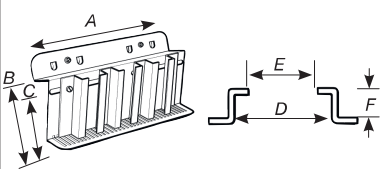

Drill/Punch stand 18	Item no.	Type	Hole in mm	Quantity
 For twist drills, reamers, punches, etc.	20.56.01	5/10	Ø 5	10
	20.56.02	7/10	Ø 7	10
	20.56.03	9/8	Ø 9	8
	20.56.04	11/7	Ø11	7
	20.56.05	13/6	Ø13	6
	20.56.06	16/6	Ø16	6
	20.56.07	19/5	Ø19	5
	20.56.08	22/4	Ø22	4
Screwdriver holder 18B	Item no.	Hole in mm Quantity		
 For screwdrivers etc. Length 200 mm.	20.56.10	Ø 7 13		
	20.56.11	Ø13 8		
Screwdriver holder 18C	Item no.	Hole in mm Quantity		
 For screwdrivers etc. Length 200 mm.	20.56.12	Ø 7 13		
	20.56.13	Ø13 8		
Bit holder 18V	Item no.	W x H x D		
For bits. Number of holes: 16 Hole dimensions Ø 8 mm.	20.57.11	100 x 57 x 95		
Grinding bit holder 19	Item no.	Hole in mm	Shank length in mm	
For grinding bits; takes 5 per holder.	20.57.01	Ø 3.5	15	
	20.57.02	Ø 6.5	20	
	20.57.03	Ø 6.5	30	
Slotting/parting off holder 20	Item no.	Dim. in mm		
For slotting and parting off.	20.58.01	Width 39		
	20.58.02	Width 58		
Lathe tool holder 21	Item no.	Mount dim. W x D mm		
	20.59.01	27 x 27		
	20.59.02	33 x 27		
Lathe tool holder 21B	Item no.	Mount dim. W x D mm		
Form positioning on table or shelf. Consists of 4 pull-out cassettes with mount dim. 27 x 27 mm and 33 x 27 mm.	20.59.03	300 x 400		



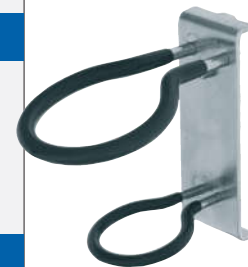
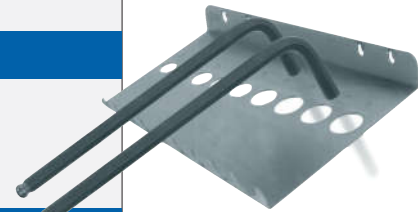



Chuck jaw holder 22	Item no.	Takes	
Intended for lathe chuck jaws. 	20.60.01	3x A x B x C x D x E x F	
	20.60.02	3x 150 x 80 x 50 x 25 x 18 x 7	
	20.60.03	3x 200 x 100 x 70 x 42 x 28 x 12	
	20.60.03	4x 270 x 100 x 70 x 42 x 28 x 12	
Hex key stand 23	Item no.	Keys in dim. in mm	
Intended for hex keys.	20.61.01	1-10	
	20.61.02	11-19	
	20.61.03	1/16"-3/4"	
	20.61.03	1/16"-3/4"	
Ring holder 26 straight model	Item no.	Steel wire dim.	Ø (internal) in mm
	20.64.01	4	30
	20.64.02	4	40
	20.64.03	6	50
	20.64.04	6	60
	20.64.05	6	70
	20.64.06	6	80
	20.64.07	6	95
	20.64.08	8	110
	20.64.09	8	125
	20.64.10	8	150
	Ring holder 27 angled model	Item no.	Steel wire dim.
	20.65.01	4	30
	20.65.02	4	40
	20.65.03	6	50
	20.65.04	6	60
	20.65.05	6	70
	20.65.06	6	80
	20.65.07	6	95
	20.65.08	8	110
	20.65.09	8	125
	20.65.10	8	150
	Ring holder 27B angled model	Item no.	For NC Internal measurement
 With double rings to take ISO TAPER ADAPTERS. Plastic coated.	20.65.15	ISO-30	34
	20.65.16	ISO-40	43
	20.65.17	ISO-45	58
	20.65.18	ISO-50	71
	20.65.19	ISO-60	108
	Capto holder	Item no.	
Ready-made shelf and holder for your tools with Capto attachment. Ready to hang up on your X-ponent tool board.	22.10.05	CAPTO C4	
	22.10.04	CAPTO C5	
	22.10.02	CAPTO C6	
	22.10.03	CAPTO C8	
	22.10.03	CAPTO C8	

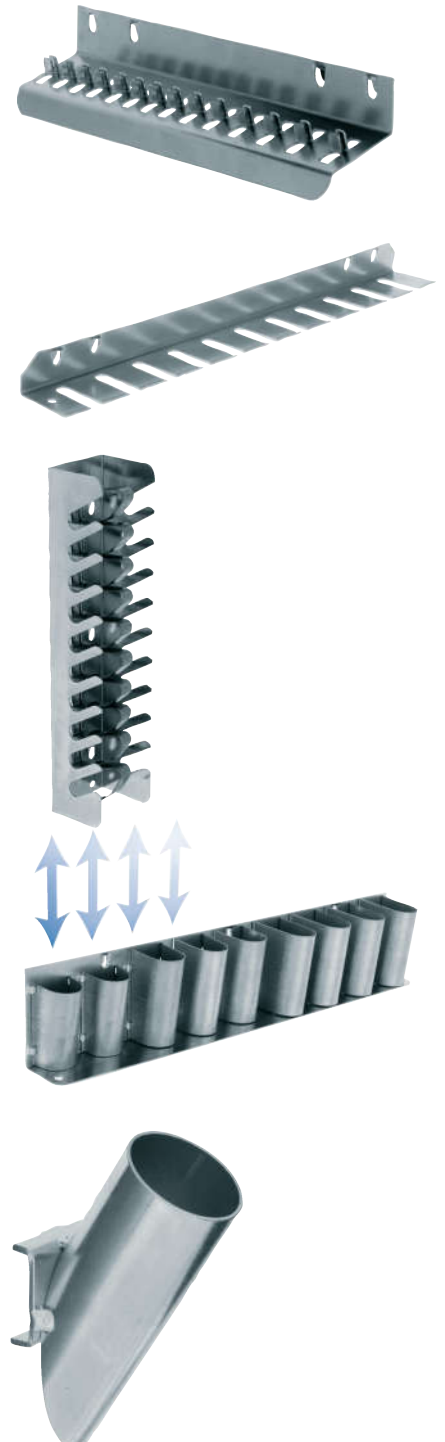

VERTICAL STORAGE SYSTEM – ONE OF EUROPE'S BIGGEST RANGES

Socket rack 28	Item no.	Square drive	Quantity	mm
Intended for nut sockets, made from strong galvanized steel. * for thicker sockets	20.66.01	1/4"	14	230
	20.66.02	3/8"	14	370
	20.66.03	1/2"	13	400
	20.66.04*	1/2"	10	400
	20.66.05	3/4"	7	400
	20.66.06*	3/4"	6	400
	20.66.07	3/8"	10	240
	20.66.08	1/2"	10	290
	20.66.09*	1/2"	7	290
	File rack 29	Item no.	Slot dim. in mm	Quantity accommodated
 Intended for shank files, articulated wrenches etc. Length 400 mm.	20.67.01	20 x 7		11
	20.67.02	30 x 10		11
	20.67.03	35 x 12		8
Holder 29B	Item no.	mm		
 Intended for e.g. standard spanners or similar tools. The holder has space for 10 tools, held steady in the holder with the aid of the spring.	20.67.04	280		
Holder 30	Item no.	W x H mm		
Tool holder with compartments for various tools. An all-round holder with three different compartment sizes. Length 400 mm. All compartments can be removed.	20.68.01	420 x 75		
Tube stand 31	Item no.	Ø in mm (internal)		
	20.69.01	9		
	20.69.02	11		
	20.69.03	13		
	20.69.04	16		
	20.69.05	22		
	20.69.06	26		
	20.69.07	32		
	20.69.08	41		









Tube stand 32	Item no.	Ø (internal) x height in mm
 From 04 to 08 angled tube. 20°	20.70.01	15 x 85
	20.70.02	30 x 60
	20.70.03	40 x 75
	20.70.04	15 x 75
	20.70.05	23 x 75
	20.70.06	26 x 75
	20.70.07	32 x 75
	20.70.08	40 x 75
Tube stand special 33B	Item no.	Ø (internal) x height in mm
 Can be used for jemmies, pliers etc. Ideal in conjunction with holder 33	20.71.04	52 x 50
Holder 33	Item no.	Ø (internal)
 For oilcans etc.	20.71.01	63
	20.71.02	78
	20.71.03	86
Can holder 33C	Item no.	Ø (internal) x height in mm
	20.71.05	70 x 75
	20.71.06	82 x 75
Holder with cover 34B	Item no.	L x W x H mm
For e.g. protective eye glasses.	20.72.02	167 x 70 x 75
Label holder 38	Item no.	mm
In stainless steel with base for X-ponent panel.	20.76.01	25 x 25
	20.76.02	50 x 25
	20.76.03	100 x 25

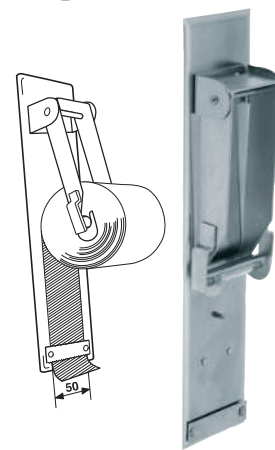
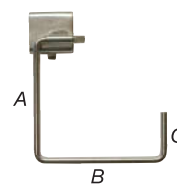

VERTICAL STORAGE SYSTEM – ONE OF EUROPE'S BIGGEST RANGES





Reel holder	Item no.	A x B x C	
For cable reels.	20.09.01	100 x 80 x 45	
	20.09.02	100 x 105 x 45	
	20.09.03	150 x 105 x 50	
	20.09.04	200 x 105 x 50	
	20.09.05	250 x 105 x 50	
Abrasive belt holder 35	Item no.		
For abrasive belts up to 50 mm wide. Version with holes for fixing with wood screws also in stock.	20.73.01	For X-ponent panel	
	20.73.02	With holes for wood screws	
Holder 36	Item no.	Internal Ø x height	
For O-rings, hydraulic gaskets etc.	20.74.01	35 x 60	
	20.74.02	45 x 60	
	20.74.03	55 x 60	
	20.74.04	65 x 70	
	20.74.05	75 x 70	
	20.74.06	85 x 80	
	20.74.07	95 x 80	
	20.74.08	105 x 80	
	20.74.09	125 x 100	
	20.74.10	145 x 100	
BR-X Stainless steel box	Item no.	Type	Dimension in mm
Ideal for use in service vehicles	20.87.13	BR-X 8	(L x W x H) 165 x 90 x 70
	20.87.17	BR-X 16	405 x 205 x 135
	20.87.20	BR-X 10	220 x 130 x 100
Holder	Item no.	Type	Dim. Ø x height in mm
For dipsticks or funnels.	20.87.21	Dipstick	145 x 123



Drill stand 40	Item no.	L x W mm	
 <p>For cylindrical drill bits. Drilled holes from 1.5 to 13 mm, in increments of 0.5.</p>	20.77.01	200 x 45	
Drill stand 41	Item no.	L x W mm	
 <p>For cylindrical drill bits. Marked out holes from 1.5 to 18 mm, in increments of 0.5.</p>	20.78.01	360 x 80	
Drill stand 42	Item no.	mm	
 <p>For cylindrical drill bits. For positioning on table or shelf. Marked out holes from 1.5 to 16 mm, 4 holes per dimension.</p>	20.79.01	290 x 190 x 70	
Milling cutter stand 43	Item no.	Quantity accommodated	
 <p>Intended for positioning on table or shelf. Marked out hole rows at 2 mm spacing. Dim. 285 x 210.</p>	20.80.01 20.80.02 20.80.03	130 34 20	
	Marked out holes:	43/1 4–20 mm 43/2 22–32 mm 43/3 34–40 mm	
Milling cutter stand 44	Item no.	For dim. in mm	quantity
 <p>Made from aluminium sheet with X-ponent base. For double or single shank cutters.</p>	20.81.01 20.81.02 20.81.03 20.81.04 20.81.05 20.81.06 20.81.07 20.81.08 20.81.09	3–4 5–6 8–10 12–14 16–18 20–22 25 30 40	5 5 5 5 5 5 3 3 3
Holder 45	Item no.	For tool	
 <p>For twist drills, milling cutters, reamers, etc. With tapered base.</p>	20.82.01 20.82.02 20.82.03 20.82.04 20.82.05 20.82.06	Taper adapter 1 Taper adapter 2 Taper adapter 3 Taper adapter 4 Taper adapter 5 Taper adapter 6	



VERTICAL STORAGE SYSTEM – ONE OF EUROPE'S BIGGEST RANGES

Holder 46	Item no.	Hole	Ø internal
 <p>Holds several tools in one holder. Length 400 mm.</p>	20.83.01	Taper adapter 1	22 12
	20.83.02	Taper adapter 2	15 18
	20.83.03	Taper adapter 3	12 24
	20.83.04	Taper adapter 4	7 32
Drill cassette 47	Item no.	Contents: cassettes with taper adapter	
 <p>Cassettes for taper adapters 1-4 can be moved relative to each other on the base plate. Base plate, width 300 mm x length 410 mm.</p>	20.84.01	1, 2, 3 and 4	
Separate cassettes 47	Item no.	HoleHeight in mm	Ø internal
 <p>Make up your own cassette. Select your dimensions. Maximum of 4 per base plate.</p>	20.85.01	22 75	12
	20.85.02	15 85	18
	20.85.03	12 105	24
	20.85.04	7 120	32
	20.85.05	Base plate W: 300 mm L: 410 mm	
Tap holder 48	Item no.	Fits	
 <p>Intended for attachment to X-ponent panel, but can also be positioned on a flat surface. Each holder takes three taps. The holders offer excellent protection against damage during storage and handling. Type 01-06 also has room for a thread cutter.</p>	20.86.01	M3-M6	
	20.86.02	M7-M10	
	20.86.03	M12-M18	
	20.86.04	M20-M22	
	20.86.05	M24-M30	
	20.86.06	M32-M34	
	20.86.07	M36-M42	
	20.86.08	M45-M52	
Holder for Jahl taper adapters	Item no.	Type For taper adapter no.	Diameter in mm internal dimension x height
	20.86.11	49/1 1	27 x 40
	20.86.12	49/2 2	35 x 45
	20.86.13	49/3 3	40 x 45
	20.86.14	49/4 4	52 x 50
	20.86.15	49/5 5	60 x 40

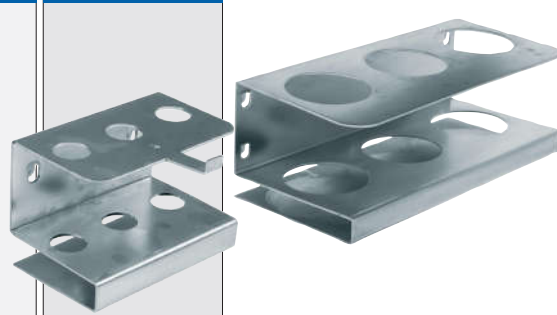
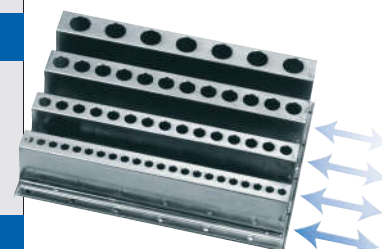



Our products are stocked as standard in colour RAL 5009, blue powder-coated, gloss level 20, rough-textured, but they are of course available in whatever colour shade you require.

1. Perforated inner doors and ends, as well as back and partition, offer outstanding vertical storage options.
2. Modular approach means outstanding flexibility in customising your work place.
3. Robust fully welded cabinets ensure rigidity and greater stability.
4. Doors on both sides.
5. Moveable, close-perforated partition allows vertical storage on both sides.
6. Mobile workstation – your tools are always close to hand.
7. Lockable doors and drawers.
8. Our blue rough-textured finish has no problem taking hard knocks and shrugs off dirt and dust.
9. The drawers can be pulled out the whole way, giving full access to and a clear view of their contents.
10. Robust wheels that can withstand heavy loads and harsh environments.
11. One of Europe's biggest ranges of hooks helps ensure your workplace is always absolutely neat and tidy.

The illustration shows our X-HUH cabinet, item no. 13.23.01

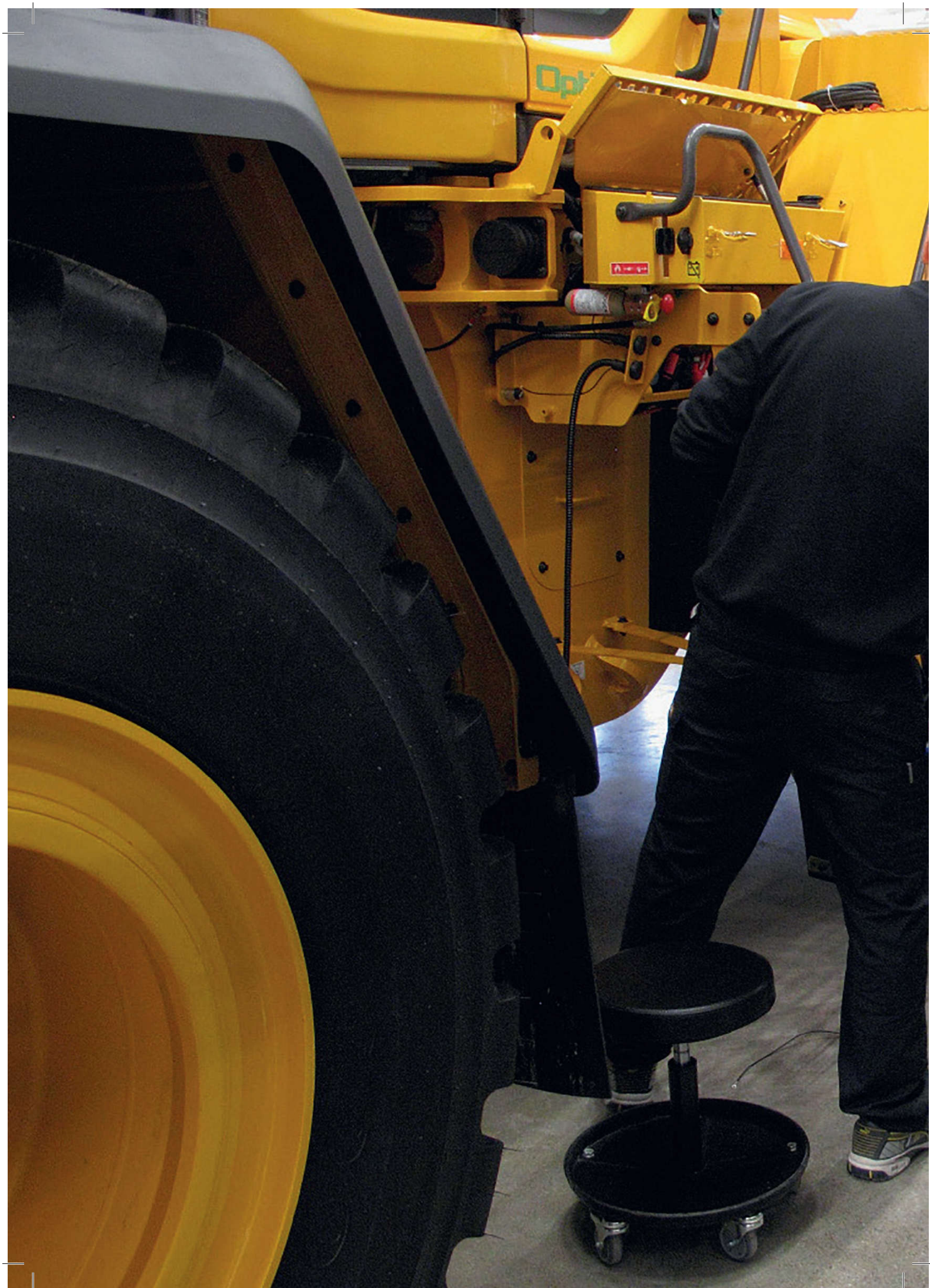

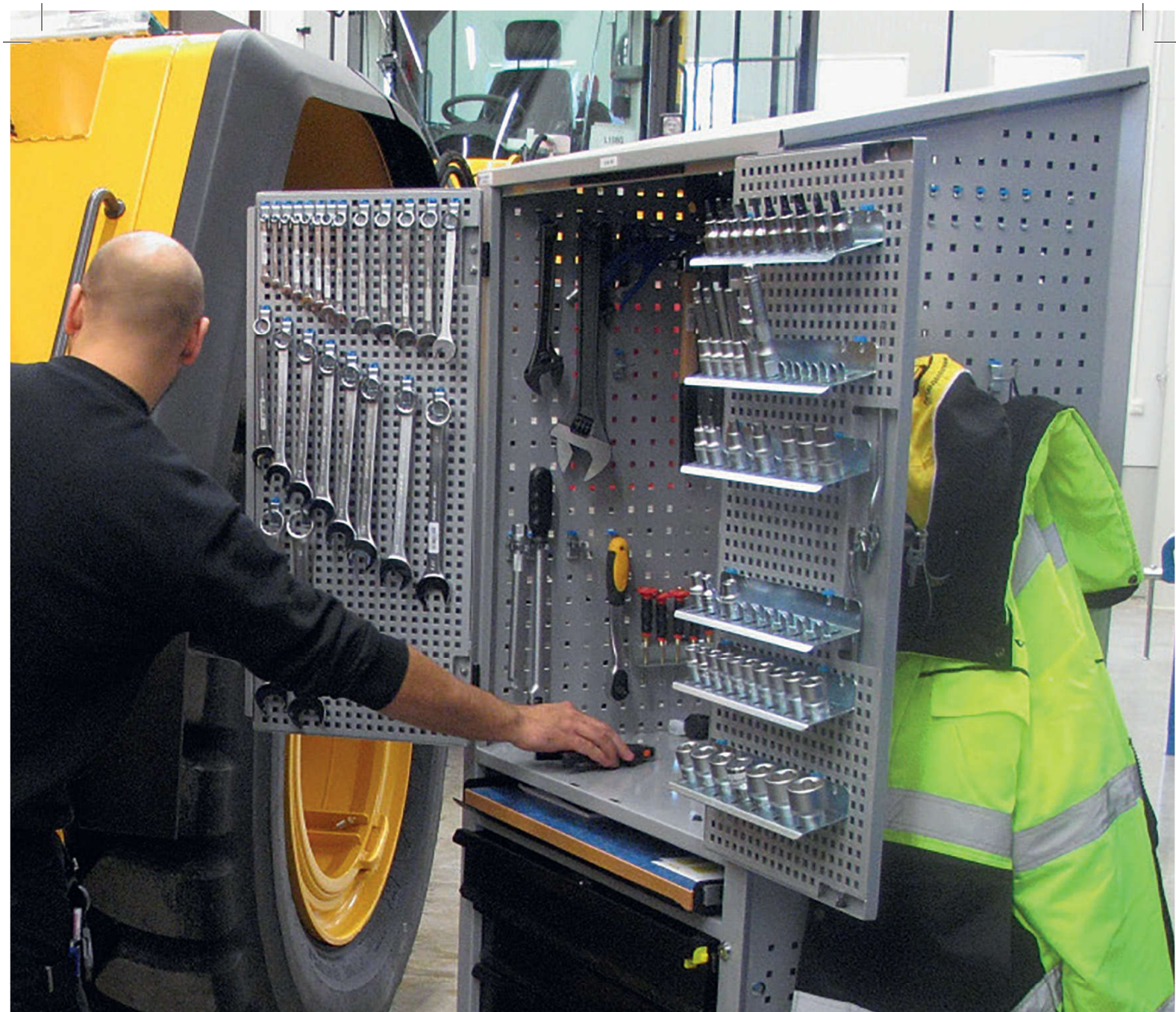

INFORMATION

General terms and conditions of sale

All prices apply ex-Eskilstuna and are exclusive of VAT. An additional charge is made for packing and packaging.

NL 09 General Terms and Conditions of Delivery apply. Delivered goods remain the property of X-ponent Inredning AB until paid for in full.

A service charge of SEK 50 will be levied on orders of less than SEK 300 in total.

Terms of payment

30 days net from date of invoice. We reserve the right to make changes in price and design.

In the event of damage in transit and any complaints, the following steps must be taken:

Visible damage to the goods must be notified to the haulier immediately on receipt.

X-ponent Inredning AB must also be notified without delay.

All damage and other complaints must be notified not later than seven days after receipt. This also applies to products that are found to be damaged when unpacked. Delivered goods may not be returned until arrangements have been agreed with X-ponent Inredning.

Goods that are the subject of a special order will not be exchanged.





Dealer

X-ponent Inredning AB
Hejargatan 5, SE-632 29 Eskilstuna, Sweden
Tel.: +46 (0)16 12 56 20
Fax: +46 (0)16 12 10 15
x-ponent.se